

















1		17pcs	C		4pcs		24pcs
2		8pcs			2pcs		8pcs
4		2pcs	D		8pcs		40pcs
A		2pcs		 M6*15MM	8pcs		1pc
B		2pcs			2pcs		7pcs
					41pcs		1pc

1



2

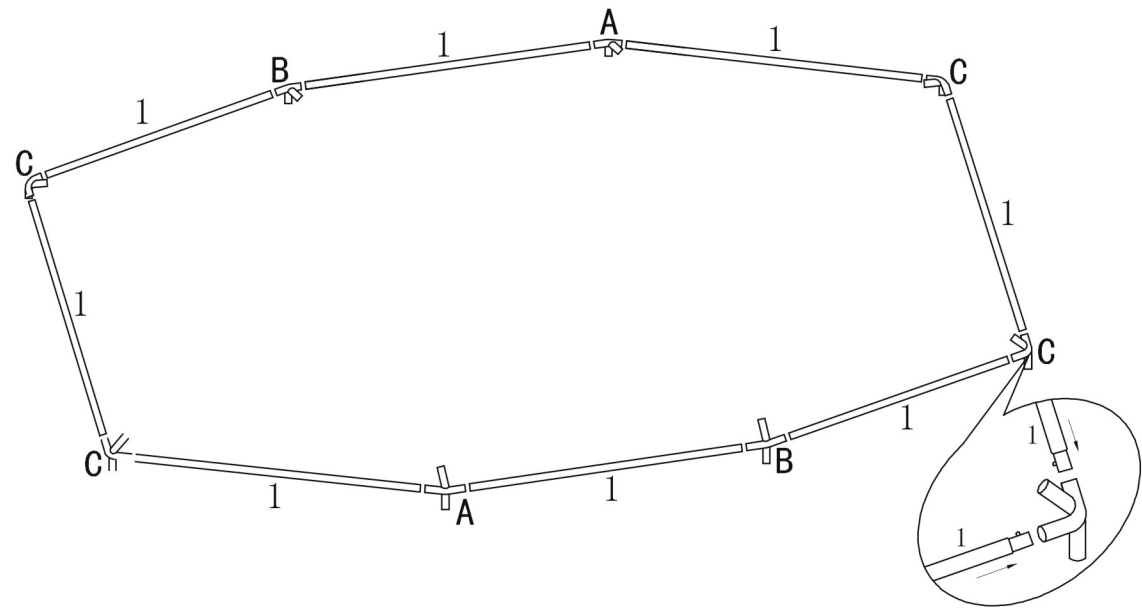
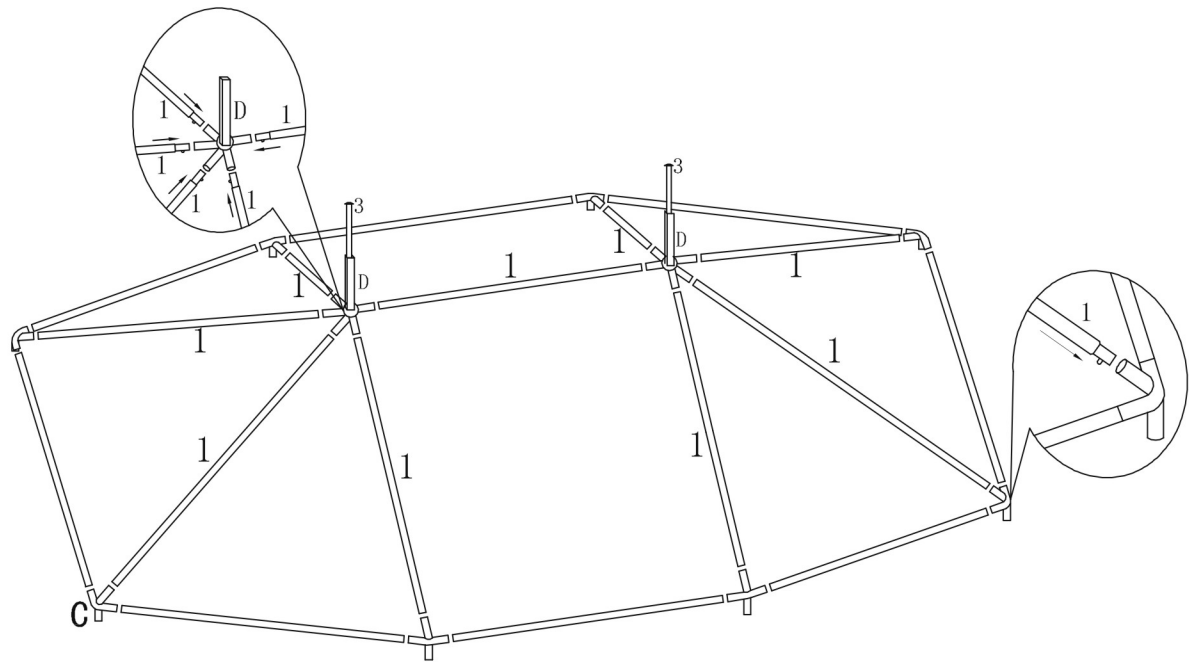

3

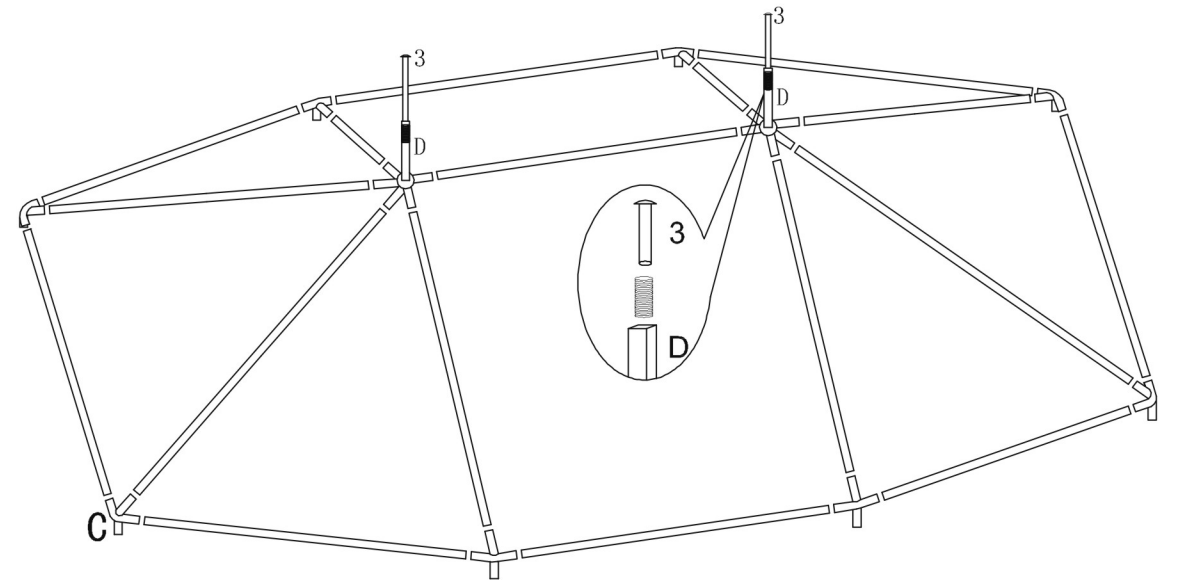

4

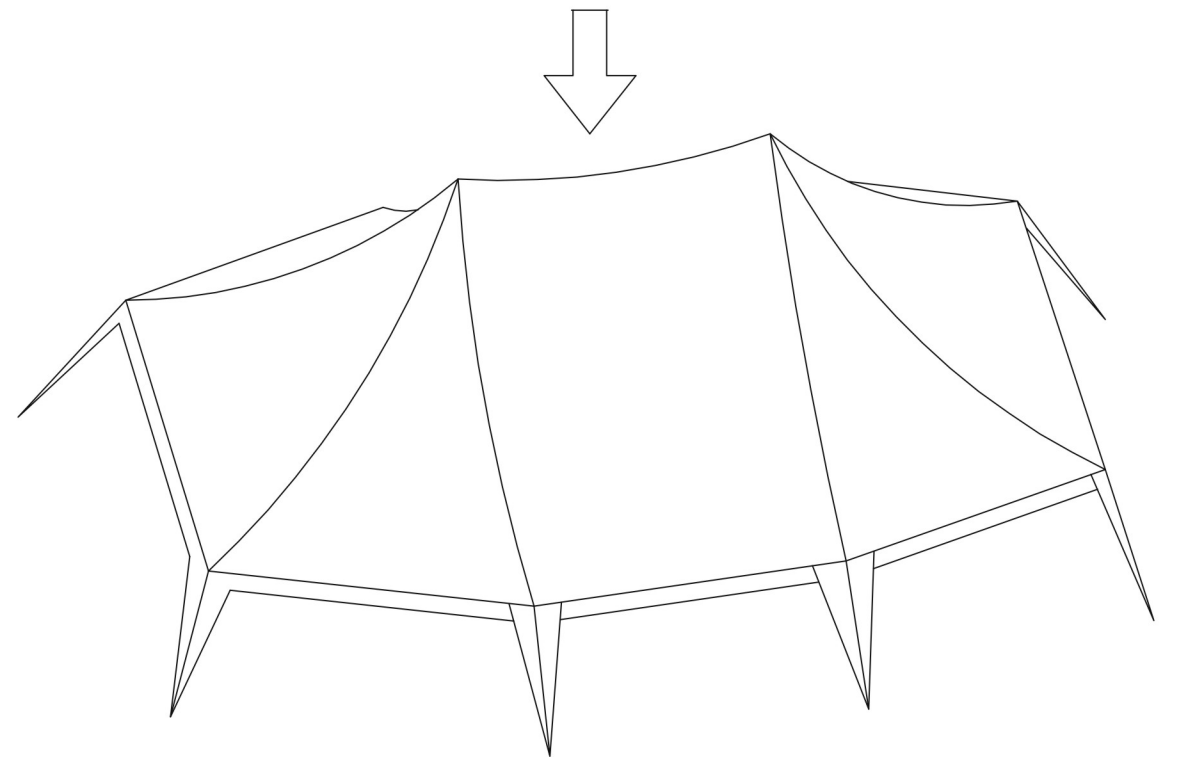

5

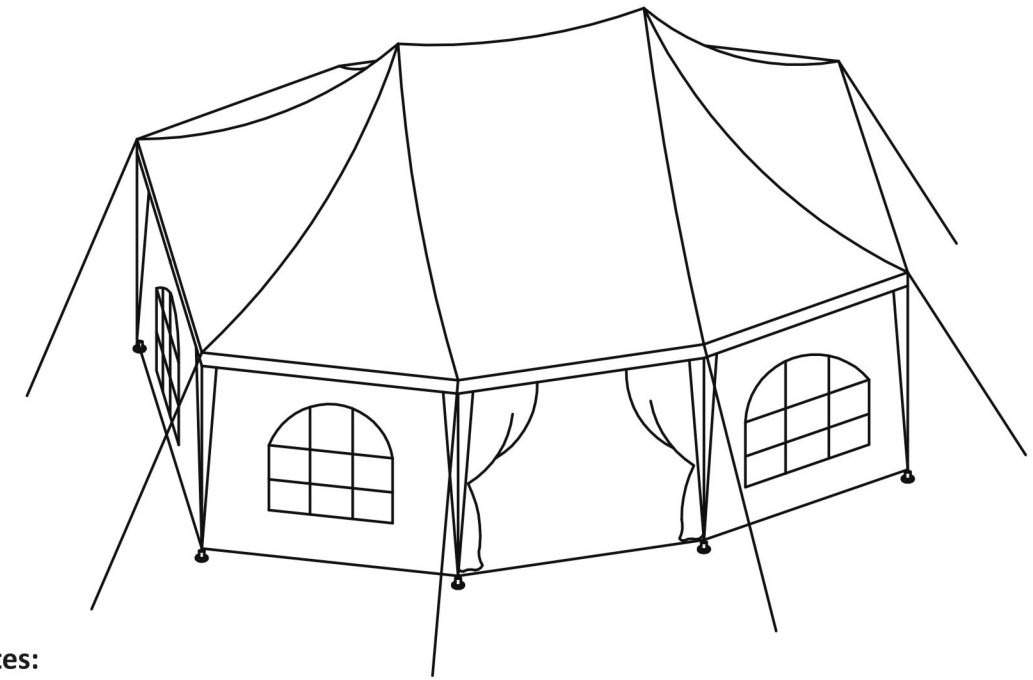

Safety Notes:

Read all instructions carefully before using this article. Retain them for future reference and if you are passing this product to a third party, always make sure this documentation is included.

- Ensure that you have all parts listed above. Please contact Wido if any of the parts are missing. Do not assemble this gazebo until you have all the parts.
- This party gazebo requires minimum two persons to assemble.
- Ensure that you have enough space around to lay all parts below assembly.
- Because of the size of the gazebo, we recommend that it is built in the place intended for using.
- Keep children and pets away when assembly.
- Please ensure that the gazebo is assembled correctly and secure before use with ground pegs and guy ropes provided.
- Ensure that all poles are fully inserted and secure.
- Take extra caution during assembly, do not climb on the structure and watch your fingers.
- Do not use the gazebo under windy conditions or in heavy rain. We recommend checking your local weather forecast before erecting your gazebo.
- **Gazebos are temporary structures and are not suitable for long-term use.** They should be assembled and dismantled on the day of use to avoid damage during the night when weather can change dramatically.
- Do not leave this gazebo unattended when erected. Supervise children when in use.
- Do not erect this gazebo near gas or electric heaters, BBQs, fireplaces, candles, radiators or any other sources of heat, fire or flammable liquids. Do not use naked flames in or around the gazebo. Do not smoke near or inside the gazebo.
- Inspect the structure for any damage or signs of wear before each assembly and dismantling

6

Important!
Remember to secure the gazebo with guy ropes and ground pegs!

