

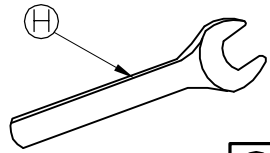

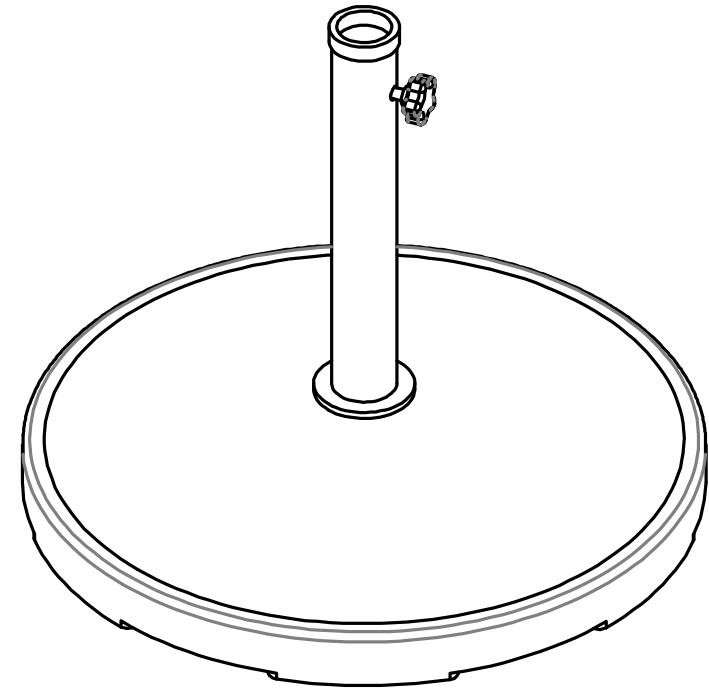

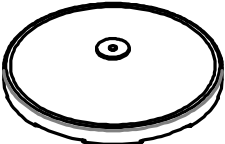



∅ 35 ∅ 38 ∅ 48



<p>(A)</p>  <p>x1</p>	<p>(B)</p>  <p>x1</p>	<p>(C)</p>  <p>x1SET</p>	<p>(D)</p>  <p>x1</p>	<p>(E)</p>  <p>x1</p>	<p>(F)</p>  <p>x1</p>	<p>(G)</p>  <p>x1</p>	<p>(H)</p>  <p>x1</p>
--	--	---	--	--	--	--	--