

945-238

–

945-240



**SE** Bruksanvisning för magnettavla

**NO** Bruksanvisning for magnettavle

**PL** Instrukcja użytkownika dot. płyty magnetycznej

**EN** User instructions for magnetic board

**Tillverkare/ Produsent / Producenci/ Manufacturer**

Jula AB, Box 363, 532 24 SKARA

Rätten till ändringar förbehålles. Vid eventuella problem, kontakta vår serviceavdelning på telefon 0200-88 55 88.

[www.jula.se](http://www.jula.se)

**Distributör/ Distributør/ Dystrybutor/ Distributor**

Jula Poland Sp. z o.o., ul. Malborska 49, 03-286 Warszawa, Polska

Z zastrzeżeniem prawa do zmian. W razie ewentualnych problemów skontaktuj się telefonicznie z naszym działem obsługi klienta pod numerem: 22 338 88 88.

[www.jula.pl](http://www.jula.pl)

**Importör/ Importør/ Importer/ Importer**

Jula Norge AS, Solheimsveien 6–8, 1471 LØRENSKOG

Med forbehold om endringer. Ved eventuelle problemer kan du kontakte vår serviceavdeling på telefon 67 90 01 34.

[www.jula.no](http://www.jula.no)

Jula reserves the right to make changes. In the event of problems, please contact our service department.  
[www.jula.com](http://www.jula.com)

**SE** - Bruksanvisning i original

**NO** - Bruksanvisning (Oversettelse av original bruksanvisning)

**PL** - Instrukcja obsługi (Tłumaczenie oryginalnej instrukcji)

**EN** - Operating instructions (Translation of the original instructions)

Date of production: 2015-06-23

© Jula AB

|                      |          |
|----------------------|----------|
| <b>SVENSKA</b> ..... | <b>4</b> |
| MONTERING .....      | 4        |
| <b>NORSK</b> .....   | <b>5</b> |
| MONTERING .....      | 5        |
| <b>POLSKI</b> .....  | <b>6</b> |
| MONTAŻ .....         | 6        |
| <b>ENGLISH</b> ..... | <b>7</b> |
| INSTALLATION .....   | 7        |

**Läs dessa anvisningar noga före användning.**

Spara dessa anvisningar för framtida behov.

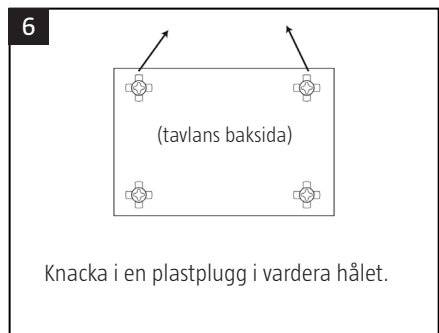
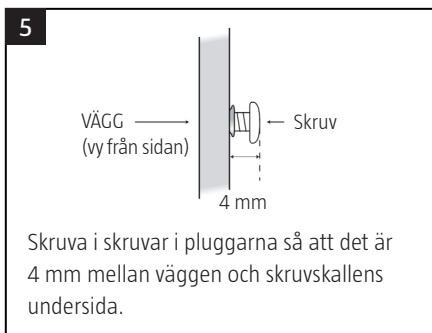
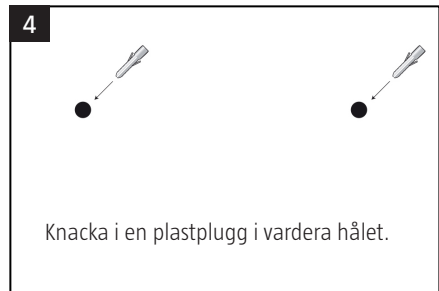
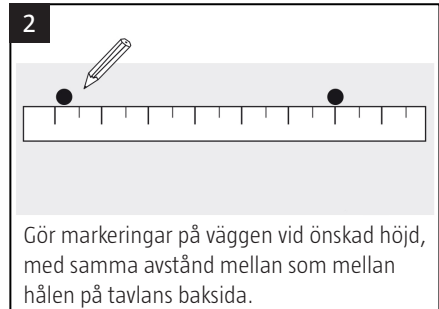
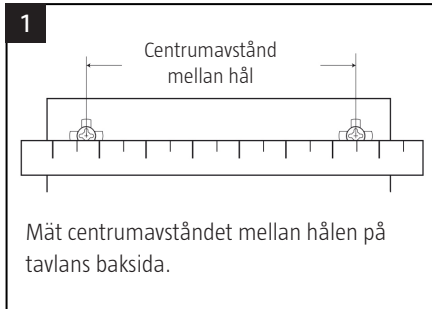
**MONTERING**

**Les bruksanvisningen nøye før bruk!**

Ta vare på dem til fremtidig bruk.

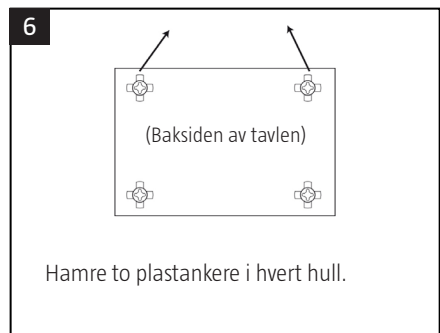
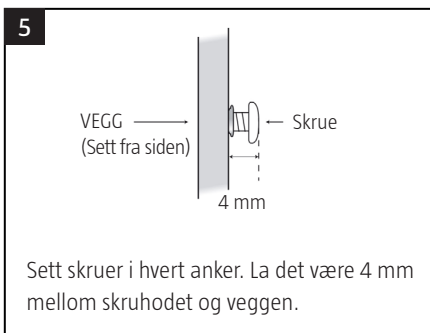
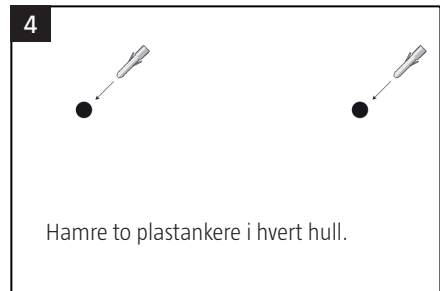
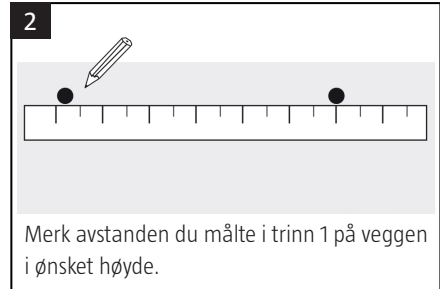
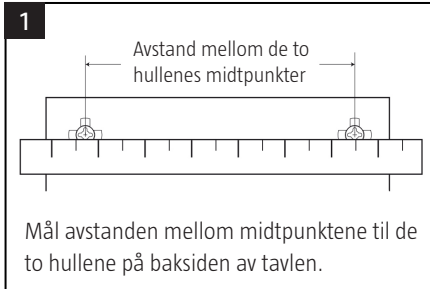
**MONTERING**

**Przed użyciem przeczytaj uważnie instrukcję użytkownika!**

Zachowaj tę instrukcję do późniejszego wykorzystania.

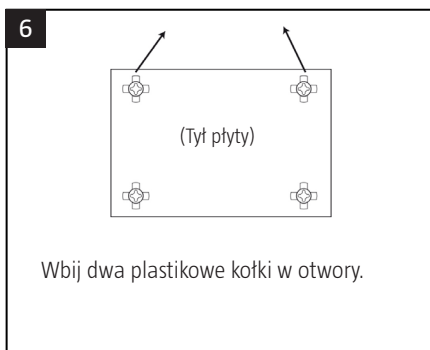
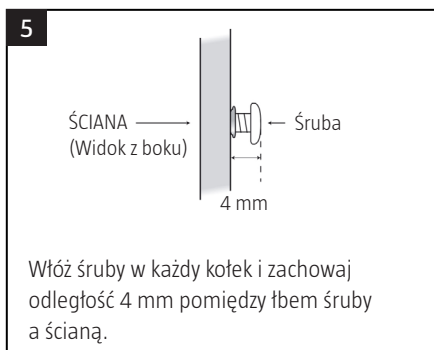
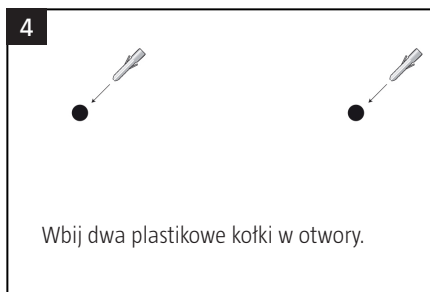
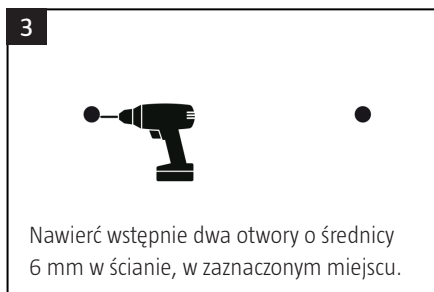
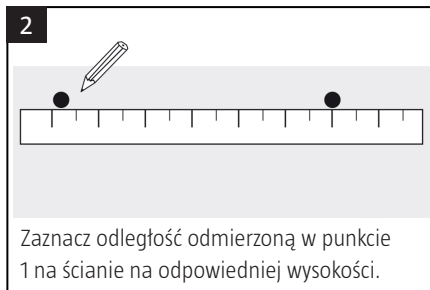
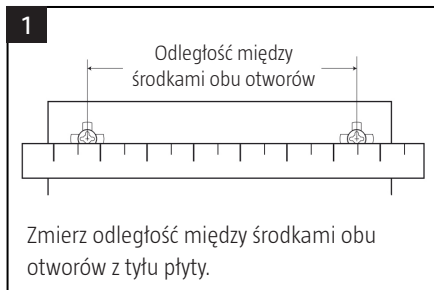
**MONTAŻ**

**Read the user instructions carefully before use!**

Save these instructions for future reference.

**INSTALLATION**