



EV Portable Charger User Manual



Enjoy it.

Please read this instruction carefully
before using the product.

CONTENTS ENGLISH	INDHOLDSFORTEGNELSE DANSK	INHALTSVERZEICHNIS DEUTSCH
01-10	11-20	21-30
INHOUD NEDERLANDS	CONTENIDOS ESPAÑOL	SISÄLTÖ SUOMALAINEN
31-40	41-50	51-60
CONTENU FRANÇAISE	INDICE ITALIANO	SPIS TREŚCI POLSKI
61-70	71-80	81-90
ÍNDICE PORTOGHESE	INNEHÅLL SVENSK	INNHOLDSFORTEGNELSE NORSK
91-100	101-110	111-120

EV Portable Charger

Please carefully read the following instructions before charging your Electrical Vehicle, be aware of the hazards involved with electrical circuitry and standard practices for preventing accidents.

English	Contents
----------------	-----------------

Introduction to the Portable EV Charger (Mode 2)	02
Explanation of the operating display and technical parameters	03
Explanation of the "⚡" and "⚡!" symbol	05
Use	06
Use of the charger - start charging	06
Use of the charger - stop charging	07
Display Light Status	08
Function	09
Switch current	09
Timer function	10

Introduction to the Portable EV Charger (Mode 2)

CAUTION

- Use the power source with external upstream Circuit Breaker.
- Make sure the charger is used in a safe, secure place and well out of the reach of young children or pets.
- Please use the charger in a dry, well ventilated and secure place. Keep well out of reach of young children or pets. Avoid water pouring directly onto the power plug.
- Do not open the enclosure while charging or with the power on.
- Do not maliciously damage the product.

Introduction to the Portable EV Charger (Mode 2)

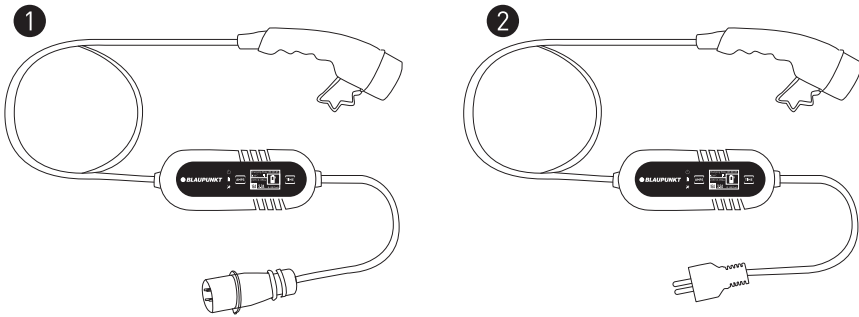

Specifications

Model	Power Supply Type	Cable Total Length	Voltage	Current	Connector Type
P1PM2T2	Single-phase	8m	200-250V	8/10/13/16A	T2
P1PM2T1	Single-phase	8m	200-250V	8/10/13/16A	T1
P1PM2T2C	Single-phase	8m	200-250V	8/10/13/16A	T2
P3PM2T2	Three-phase	8m	380-450V	8/10/13/16A	T2
P1PM2T2BS	Single-phase	8m	200-250V	8/10/13A	T2
P1PM2T1BS	Single-phase	8m	200-250V	8/10/13A	T1
P3P6MT2	Three-phase	6m	380-450V	8/10/13/16A	T2
P1P6MT2	Single-phase	6m	200-250V	8/10/13/16A	T2
P1P6MT2L	Single-phase	6m	200-250V	8/10/13/16A	T2
P1PM2T2L	Single-phase	8m	200-250V	8/10/13/16A	T2
P1PM2T2CH	Single-phase	8m	200-250V	8/10A	T2
P1PM2T2DK	Single-phase	8m	200-250V	6A	T2

Explanation of the operating display and technical parameters

1 Model: P3PM2T2 / P3P6MT2

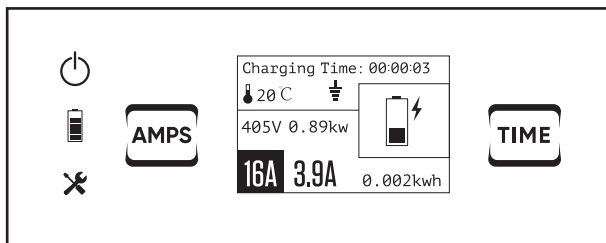

Explanation of the operating display

	Power light	405V	Voltage
	Charge lamp	0.89kw	Power
	Trouble lamp	16A	Rated current
	Current switch button	3.9A	Constant current
00:00:03	Charging time	0.002kwh	Electricity consumption
	Temperature		Time function button
	PE Detection (Earthing Detection)		The upstream PE has not been detected and the charging cannot be started.

Control box :

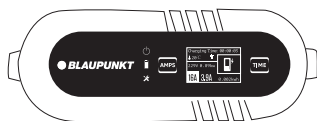

Technical Parameters

Dimensions (L×W×H)	260×100×72.5 mm
Weight	3Phase: 3.35 kg / 2.9 kg
Protection Degree (Control box)	IP65
Operating Temperature	-30°C to +50°C

Explanation of the operating display and technical parameters

- 1 Model: P1PM2T2 / P1PM2T1 / P1PM2T2C / P1PM2T2BS / P1PM2T1BS
P1P6MT2 / P1P6MT2L / P1PM2T2L / P1PM2T2CH / P1PM2T2DK

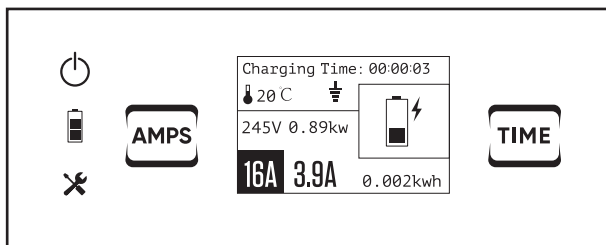

Explanation of the operating display

	Power light	245V	Voltage
	Charge lamp	0.89kw	Power
	Trouble lamp	16A	Rated current
	Current switch button	3.9A	Constant current
00:00:03	Charging time	0.002kwh	Electricity consumption
	Temperature		Time function button
	PE Detection (Earthing Detection)		The upstream PE has not been detected and the charging cannot be started.

Control box :

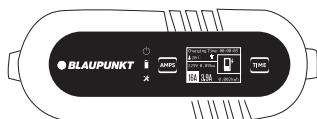

Technical Parameters

Dimensions (L×W×H)	260×100×72.5 mm
Weight	1Phase: 2.41 kg / 2.15 kg
Protection Degree (Control box)	IP65
Operating Temperature	-30°C to +50°C

Explanation of the "⚡" and "⚡!" symbol

Users must check the PE detection mark "⚡" on the display before each use.
(PE meaning protective conductor)

1. If the Mark "⚡" is displayed on the screen, it indicates that the charger shall verify the presence of the upstream PE, and the charging process will only begin when the upstream PE is present.

ATTENTION: if the mark "⚡!" appears, it means that the upstream PE has not been detected and the charging cannot be started.

2. If the Mark "⚡" is NOT displayed on the screen, it indicates that the charger has no function to verify the presence of the upstream PE, and can be charged whether or not the PE can be detected.

ATTENTION: It is strongly recommended that users charge under condition 1. condition 2 has certain security risks due to the absence of PE. So condition 2 should only be used under the premise that users can ensure safety and in special circumstances where PE does not exist in the power system.

Deactivate PE Detection :
Reactivate PE Detection:

Press "Amps+Time" for 4s together.
Press "Amps+Time" for 4s together.

Use of the charger - start charging

Start Charging

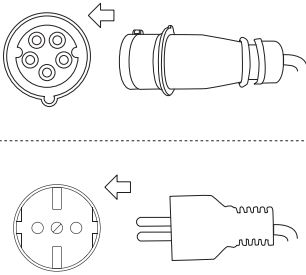
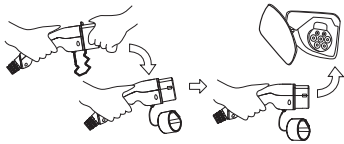
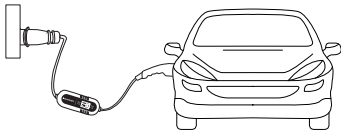

Step	Illustration	Operation
1.		Insert the plug into the correct power supply socket.
2.		Remove the protective cap and fully insert the charging connector into the EV charging port.
3.		Start charging

DANGER

- Do not use product if it appears to be damaged or the cable is broken.
- Do not disassemble or assemble the connector and change the internal parts.
- Do not clean the products using chemicals or cleaning the EV car while charging.



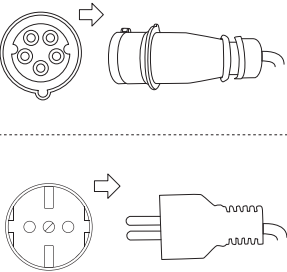
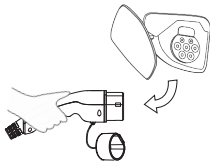
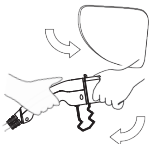





Use of the charger - stop charging

Stop Charging



















Step	Illustration	Operation
1.		Disconnect the plug from the power supply socket.
2.		Disconnect the charging connector from the EV car.
3.		Close the protective shell of EV charging port, then cover the protective cap of the charging connector.
4.		Put the portable charger into the bag.

Display Light Status

























Display Light Status

Indicator Light	Status	Indicator Light	Status	Indicator Light	Status
	Off		Blink		On
	Off		Blink		On
	Off		Blink		On

Operation:

1	Power Off			
2	Check			
3	Standby			
4	Connected			
5	Charging			
6	Charge Complete			

Trouble shooting:

1	CP Error			
2	Relay Error			
3	Over/Under Voltage			
4	Over current protection			
5	Electric leakage protection			
6	No ground connection			
7	Temperature warning			
8	Persistent high temperature			

Function: Switch Current

Switch Current:



In order to switch charging current, please make sure the power plug is firmly inserted into the socket and plug for the EV vehicle is disconnected.

Step	Illustration	Status
<p>1. Insert the plug into the correct power supply socket.</p>		<p>Ready</p>
<p>2. Press the "Amps" switch button for 2 seconds.</p>		<p>Enter setting the switch current mode</p>
<p>3. Continue to press the switch briefly. The current will be changed. (switch between 8-10-13-16A).</p>		<p>Setting the current of User's request</p>
<p>4. Press the button for 2s again.</p>		<p>Setting successfully</p>



Please complete setting within 4 seconds at each step, otherwise the feature setting will fail.

Function: Timer Function

Timer function:

⚠ CAUTION

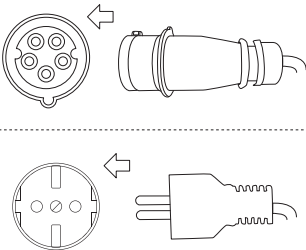
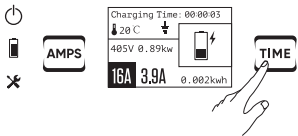
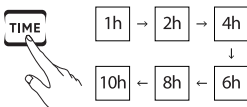
In order to switch charging current, please make sure the power plug is firmly inserted into the socket and the plug for EV vehicle is disconnected.

Step	Illustration	Status
1. Insert the plug into the correct power supply socket.		Ready
2. Press the "Time" switch button for 2 seconds.		Enter setting the delay time mode
3. Continue to press the button briefly. The time will be changed. (Switch between 1/2/4/6/8/10H).		Setting the delay time of User's request
4. Press the button for 2s again.		Setting successfully

Please complete setting within 4 seconds at each step, otherwise the feature setting will fail.

Notice:

In case you want to cancel the timer setting - you can use one of the two options below:



1. Directly to disconnect the plug from the outlet socket.
2. Press the Time button for 5s.

Bærbar EV-oplader

Læs omhyggeligt nedenstående instruktioner, inden du oplader dit elektriske køretøj. Vær opmærksom på de farer, der er forbundet med elektrisk strøm og standardpraksis for at forhindre ulykker.

Dansk

Indholdsfortegnelse

Introduktion til den bærbare EV-oplader (Mode 2)	12
Betydning af betjeningsindikatorer og tekniske parametre	13
Forklaring af symbolet "  " og symbolet "  ! "	15
Brug	16
Start opladningen	16
Stop opladning	17
Lysstatusvisning	18
Function	19
Ændring af nominal strøm	19
Timer	20

Introduktion til den bærbare EV-oplader (Mode 2)

FORSIGTIG

- Brug strømkilden med en ekstern afbryder.
- Sørg for, at opladeren bruges et sikkert sted uden for rækkevidde af små børn eller kæledyr.
- Brug dette produkt i et køligt, tørt og godt ventileret område. Undgå, at der kommer vand ind i stikket.
- Åbn ikke kabinettet under opladning, eller når opladeren er tændt.
- Undgå at beskadige produktet.

Introduktion til den bærbare EV-oplader (Mode 2)

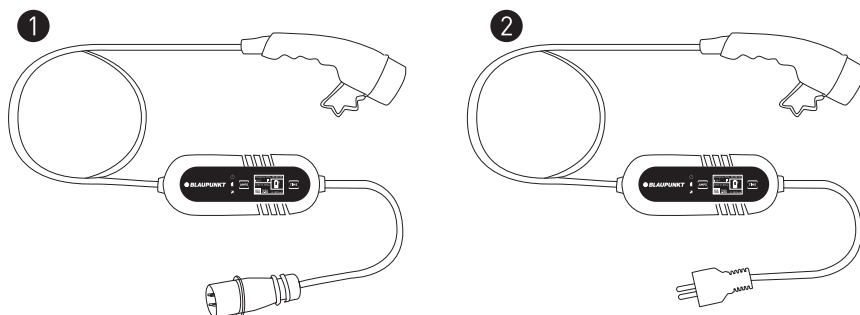

Specifikationer

Model	Strømforsyningstype	Samlet kabellængde	Spænding	Nominal strøm	Stikforbindelsestype
P1PM2T2	Enfaset	8m	200-250V	8/10/13/16A	T2
P1PM2T1	Enfaset	8m	200-250V	8/10/13/16A	T1
P1PM2T2C	Enfaset	8m	200-250V	8/10/13/16A	T2
P3PM2T2	Trefaset	8m	380-450V	8/10/13/16A	T2
P1PM2T2BS	Enfaset	8m	200-250V	8/10/13A	T2
P1PM2T1BS	Enfaset	8m	200-250V	8/10/13A	T1
P3P6MT2	Trefaset	6m	380-450V	8/10/13/16A	T2
P1P6MT2	Enfaset	6m	200-250V	8/10/13/16A	T2
P1P6MT2L	Enfaset	6m	200-250V	8/10/13/16A	T2
P1PM2T2L	Enfaset	8m	200-250V	8/10/13/16A	T2
P1PM2T2CH	Enfaset	8m	200-250V	8/10A	T2
P1PM2T2DK	Enfaset	8m	200-250V	6A	T2

Betydning af betjeningsindikatorer og tekniske parametre

1 Model: P3PM2T2 / P3P6MT2

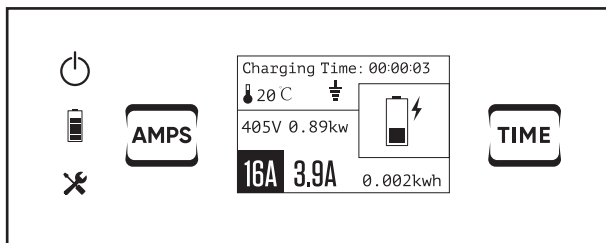

Betydning af betjeningsindikatorer

	Power tænd/sluk	405V	Spænding
	Oplader	0.89kw	Strøm
	Fejlindikator	16A	Nominel strøm
	Nominel strøm ændring-knap	3.9A	Konstant strøm
00:00:03	Opladningstid	0.002kwh	Elforbrug
	Temperatur		Timerfunktionsknap
	PE-detektion (jordingsdetektion)		Opstrøms PE er ikke blevet fundet, og opladningen kan ikke startes.

Control box :

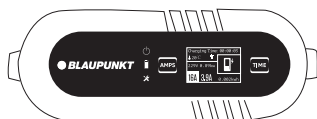

Tekniske parametre

Dimensioner (L x B x H)	260 x 100 x 72.5 mm
Vægt	3-fase: 3.35 kg / 2.9 kg
Beskyttelsesgrad (Control box)	IP65
Driftstemperatur	-30°C til +50°C

Betydning af betjeningsindikatorer og tekniske parametre

- 1 Model: P1PM2T2 / P1PM2T1 / P1PM2T2C / P1PM2T2BS / P1PM2T1BS
P1P6MT2 / P1P6MT2L / P1PM2T2L / P1PM2T2CH / P1PM2T2DK

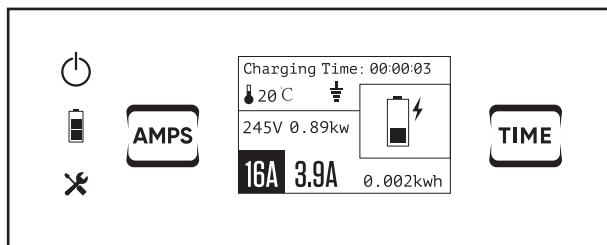

Betydning af betjeningsindikatorer

	Power tænd/sluk	245V	Spænding
	Oplader	0.89kw	Strøm
	Fejlindikator	16A	Nominel strøm
	Nominel strøm ændring-knap	3.9A	Konstant strøm
00:00:03	Opladningstid	0.002kwh	Elforbrug
	Temperatur		Timerfunktionsknap
	PE-detektion (jordingsdetektion)		Opstrøms PE er ikke blevet fundet, og opladningen kan ikke startes.

Control box :

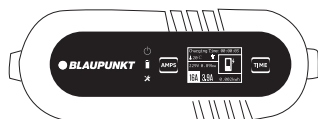

Tekniske parametre

Dimensioner (L x B x H)	260 x 100 x 72.5 mm
Vægt	1-fase: 2.41 kg / 2.15 kg
Beskyttelsesgrad (Control box)	IP65
Driftstemperatur	-30°C til +50°C

Forklaring af symbolet "⚡" og symbolet "⚡!"

Brugerne skal kontrollere PE-detektionsmærket "⚡" på displayet før hver brug.
(PE betyder beskyttelsesleder)

1.Hvis mærket "⚡" vises på skærmen, angiver det, at opladeren skal kontrollere tilstedeværelsen af opstrøms PE, og opladningsprocessen vil kun begynde, når opstrøms PE er til stede.

OBS: Hvis mærket "⚡!" vises, betyder det, at opstrøms PE ikke er tilstede, og at opladningen ikke kan startes.

2.Hvis mærket "⚡" IKKE vises på skærmen, betyder det, at opladeren ikke har nogen funktion til at verificere tilstedeværelsen af opstrøms PE og kan oplades, uanset om PE kan detekteres eller ej.

BEMÆRK: Det anbefales kraftigt, at brugerne oplader under betingelse 1. Betingelse 2 indebærer visse sikkerhedsrisici på grund af fraværet af PE. Så betingelse 2 bør kun anvendes under forudsætning af, at brugerne kan garantere sikkerheden, og under særlige omstændigheder, hvor der ikke findes PE i elsystemet.

Deaktivere PE-detektion :
Genaktivere PE-detektion:

Tryk på "Amps+Time" i 4s sammen.
Tryk på "Amps+Time" i 4 sekunder sammen.

Brug: Start opladningen

Start opladningen

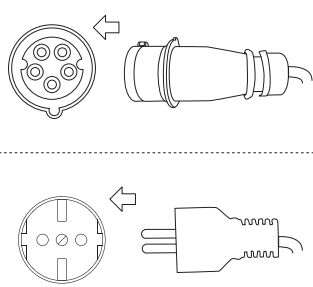
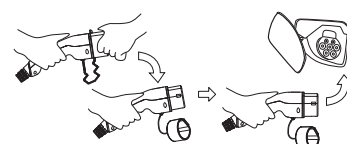
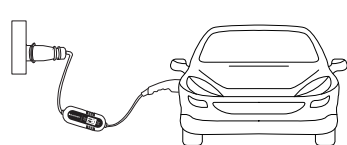
Trin	Illustration	Drift
1.		Sæt stikket i det korrekte strømforsyningsstik.
2.		Fjern beskyttelseshætten og sæt opladningsconnectoren helt ind i EV-opladningssporten.
3.		Start opladningen.



FARE

Brug ikke produktet, hvis det ser ud til at være beskadiget, eller kablet er ødelagt.

Du må ikke adskille/samle konnektoren eller udskifte dets indvendige dele.



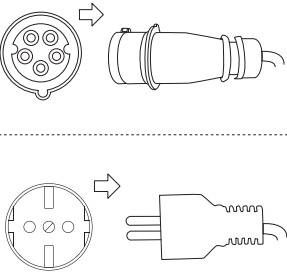
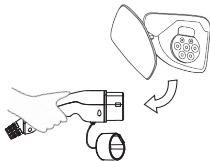

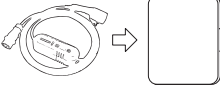



Undlad at rengøre produkterne med kemikalier eller rengøre EV-bilen under opladning.

Stop opladning



















Trin	Illustration	Drift
1.		Træk stikket ud af stikkontakten.
2.		Frakobl opladningsstikket fra EV-køretøjet.
3.		Luk beskyttelseskappen på EV-opladningsporten, og sæt beskyttelseshætten på opladningsstikket.
4.		Læg den bærbare opladeren i tasken.

Lysstatusvisning

























Lysstatusvisning

Indikatorlys	Status	Indikatorlys	Status	Indikatorlys	Status
	Off (Slukket)		Blinker		On (Tændt)
	Off (Slukket)		Blinker		On (Tændt)
	Off (Slukket)		Blinker		On (Tændt)

Betjening:

1	Sluk			
2	Check			
3	Standby			
4	Tilsluttet			
5	Oplader			
6	Opladning gennemført			

Fejlfinding:

1	CP-fejl			
2	Relæfejl			
3	Overspænding/underspænding			
4	Overstrømsbeskyttelse			
5	Elektrisk lækagesikring			
6	Ikke jordet			
7	Temperaturadvarsel			
8	Vedvarende høj temperatur			

Funktion: Ændring af nominal strøm

Ændring af nominal strøm:



Inden du skifter ladestrøm, skal du sørge for, at strømstikket er sat ordentligt i stikkontakten, og at den anden kabelende er koblet fra EV-køretøjet.

Trin	Illustration	Status
1. Sæt stikket i det korrekte strømforsyningsstik.		Klar
2. Hold knappen "Amps" nede i 2 sekunder.		Gå ind i tilstanden Aktuelle indstillinger
3. Skift mellem 8, 10, 13 og 16 A-strømme ved at trykke kort på knappen.		Indstillingen af nominal strøm efter brugerens behov
4. Tryk på knappen i 2 sekunder igen.		Indstillingen af nominal strøm er vellykket

Gennemfør indstillingen inden for 4 sekunder ved hvert trin, ellers deaktiveres indstillingstilstanden.

Funktion: Timer

Timer-funktion:



Inden du aktiverer timerfunktionen, skal du sørge for, at strømstikket er sat ordentligt i stikkontakten, og at den anden kabelende er koblet fra EV-køretøjet.

Trin	Illustration	Status
1. Sæt stikket i det korrekte strømforsyningsstik.		Klar
2. Hold knappen "Tid" inde i 2 sekunder.		Gå ind i Timer-funktionens indstillingstilstand. Timeren forsinker starten med det valgte antal timer
3. Skift mellem 1, 2, 4, 6, 8 og 10 t gange ved at trykke kort på knappen.		Indstilling af timeren efter brugerens behov
4. Tryk på knappen i 2 sekunder igen.		Timerindstillingen blev gennemført

Gennemfør indstillingen inden for 4 sekunder ved hvert trin, ellers deaktiveres indstillingstilstanden.

Bemærk:



Hvis du ønsker at annullere tidsfunktionen, efter nedtællingen er startet, kan du gøre et af følgende trin:

1. Frakobl stikket direkte fra stikkontakten, eller
2. tryk på Tid-knappen i 5 sekunder.

Tragbares Ladegerät für Elektrofahrzeuge

Bitte lesen Sie folgende Anweisungen aufmerksam durch, bevor Sie Ihr Elektrofahrzeug laden. Achten Sie auf die Gefahren, die mit dem Stromkreislauf einhergehen, sowie auf die Standardmethode zur Verhinderung von Unfällen

Deutsch Inhaltsverzeichnis

- Einführung In Das Tragbare Ladegerät Für Elektrofahrzeuge (Mode 2) 22
- Bedeutung Der Steuergerätanzeigen Und Technische Daten 23
- Erläuterung der "  " und der "  " Symbole 25
- Nutzung:** 26
 - Ladevorgang Starten 26
 - Ladevorgang Beenden 27
- Lichtstatusanzeige 28
- Funktion** 29
 - Nennstrom wechseln 29
 - Timer 30

⚠ VORSICHT

- Nutzen Sie eine Stromquelle mit einem externen Trennschalter.
- Stellen Sie sicher, dass das Ladegerät an einem sicheren Ort und außerhalb der Reichweite von kleinen Kindern oder Haustieren verwendet werden.
- Bitte nutzen Sie dieses Produkt in einem kühlen, trockenen und gut belüfteten Bereich und vermeiden Sie, dass Wasser in den Stecker gelangt.
- Öffnen Sie das Gehäuse nicht während des Ladevorgangs oder solange das Ladegerät eingeschaltet ist.
- Beschädigen Sie nicht das Produkt nicht böswillig.

Einführung in das tragbare Ladegerät für Elektrofahrzeuge (Mode 2)

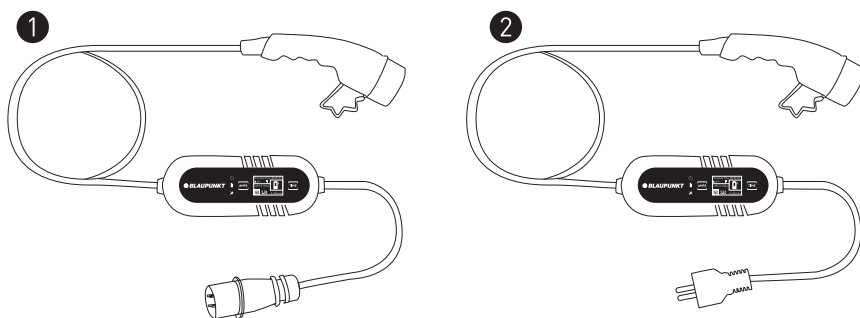

Technische Daten

Modell	Stromversorgungstyp	Gesamtkabellänge	Spannung	Nennstrom	Anschlussart
P1PM2T2	Einphasen	8m	200-250V	8/10/13/16A	T2
P1PM2T1	Einphasen	8m	200-250V	8/10/13/16A	T1
P1PM2T2C	Einphasen	8m	200-250V	8/10/13/16A	T2
P3PM2T2	Dreiphasen	8m	380-450V	8/10/13/16A	T2
P1PM2T2BS	Einphasen	8m	200-250V	8/10/13A	T2
P1PM2T1BS	Einphasen	8m	200-250V	8/10/13A	T1
P3P6MT2	Dreiphasen	6m	380-450V	8/10/13/16A	T2
P1P6MT2	Einphasen	6m	200-250V	8/10/13/16A	T2
P1P6MT2L	Einphasen	6m	200-250V	8/10/13/16A	T2
P1PM2T2L	Einphasen	8m	200-250V	8/10/13/16A	T2
P1PM2T2CH	Einphasen	8m	200-250V	8/10A	T2
P1PM2T2DK	Einphasen	8m	200-250V	6A	T2

Bedeutung Der Steuergerätenanzeigen Und Technische Daten

1 Model: P3PM2T2 / P3P6MT2

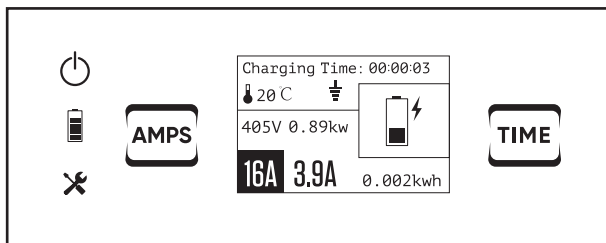

Bedeutung der Steuergerätenanzeigen

	EIN/AUS-Taste	405V	Spannung
	Ladevorgang	0.89kw	Anschlussspannung
	Problemanzeige	16A	Nennstrom
	Nennstrom wechseln-Taste	3.9A	Aktueller Strom
00:00:03	Ladezeit	0.002kwh	Stromverbrauch
	Temperatur		Timer-Funktionstaste
	PE-Erkennung (Erdungserkennung)		Die vorgelagerte PE wurde nicht erkannt und der Ladevorgang kann nicht gestartet werden.

Control box :

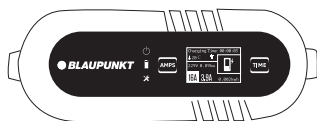

Technische Daten

Abmessungen (L x B x H)	260 x 100 x 72.5 mm
Gewicht	Dreiphas: 3.35 kg / 2.9 kg
Schutzgrad (Control box)	IP65
Betriebstemperatur	Von -30°C bis +50°C

Bedeutung Der Steuergerätenanzeigen Und Technische Daten

- 1 Model: P1PM2T2 / P1PM2T1 / P1PM2T2C / P1PM2T2BS / P1PM2T1BS
 P1P6MT2 / P1P6MT2L / P1PM2T2L / P1PM2T2CH / P1PM2T2DK

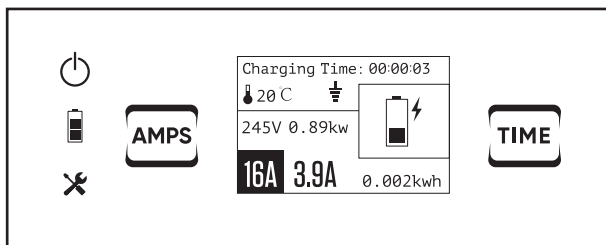

Bedeutung der Steuergerätenanzeigen

	EIN/AUS-Taste	245V	Spannung
	Ladevorgang	0.89kw	Anschlussspannung
	Problemanzeige	16A	Nennstrom
	Nennstrom wechseln-Taste	3.9A	Aktueller Strom
00:00:03	Ladezeit	0.002kwh	Stromverbrauch
	Temperatur		Timer-Funktionstaste
	PE-Erkennung (Erdungserkennung)		Die vorgelagerte PE wurde nicht erkannt und der Ladevorgang kann nicht gestartet werden.

Control box :

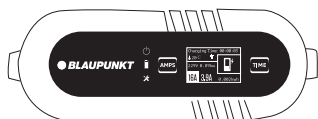

Technische Daten

Abmessungen (L x B x H)	260 x 100 x 72.5 mm
Gewicht	Einphasen: 2.41 kg / 2.15 kg
Schutzgrad (Control box)	IP65
Betriebstemperatur	Von -30°C bis +50°C

Erläuterung der "⚡" und de "⚡!" symbol

Die Benutzer müssen die PE-Erkennungsmarkierung "⚡" auf dem Display vor jedem Gebrauch überprüfen.(PE bedeutet Schutzleiter)

1.Wenn die Markierung "⚡" auf dem Bildschirm angezeigt wird, bedeutet dies, dass das Ladegerät das Vorhandensein des vorgelagerten Schutzleiters überprüfen muss, und der Ladevorgang beginnt nur, wenn der vorgelagerte Schutzleiter vorhanden ist.

ACHTUNG: Wenn die Markierung "⚡!" erscheint, bedeutet dies, dass der vorgelagerte PE nicht erkannt wurde und der Ladevorgang nicht gestartet werden kann.

2.Wenn die Markierung "⚡" NICHT auf dem Bildschirm angezeigt wird, bedeutet dies, dass das Ladegerät keine Funktion hat, um das Vorhandensein des vorgelagerten PE zu überprüfen, und dass der Ladevorgang unabhängig davon gestartet werden kann, ob der PE erkannt werden kann oder nicht.

ACHTUNG: Es wird dringend empfohlen, unter Bedingung 1 zu laden.

Bedingung 2 birgt gewisse Sicherheitsrisiken, da kein PE vorhanden ist. Daher sollte Bedingung 2 nur unter der Voraussetzung verwendet werden, dass der Benutzer die Sicherheit gewährleisten kann, und unter besonderen Umständen, wenn kein PE im Stromnetz vorhanden ist.

Deaktivieren der PE-Erkennung: Drücken Sie "Ampere+Zeit" für 4s zusammen.
PE-Erkennung reaktivieren: Drücken Sie "Ampere+Zeit" für 4s gleichzeitig.

Nutzung: Ladevorgang Starten

Ladevorgang starten

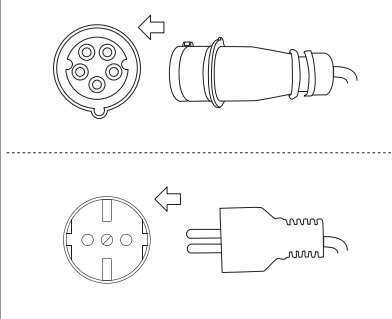
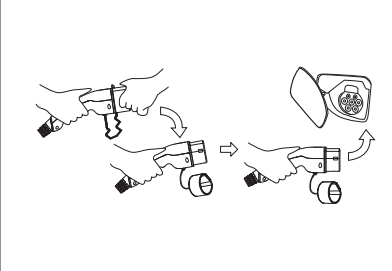
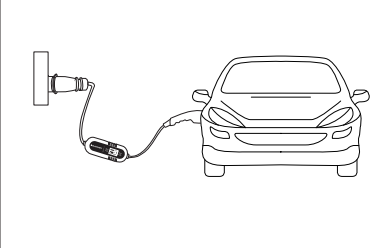
Schritt	Darstellung	Betrieb
1.		Stecken Sie den Netzstecker in die richtige Steckdose.
2.		Entfernen Sie die Schutzkappe und stecken Sie den Ladestecker vollständig in den Ladeanschluss.
3.		Starten Sie den Ladevorgang.

GEFAHR

Nutzen Sie das Produkt nicht, wenn es beschädigt zu sein scheint oder das Kabel gebrochen ist. Zerlegen oder montieren Sie den Stecker nicht und wechseln Sie die Innenteile nicht aus. Reinigen Sie die Produkte nicht mit Chemikalien und reinigen Sie das Elektrofahrzeug nicht während des Ladevorgangs.





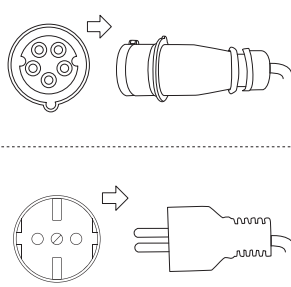
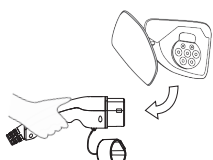
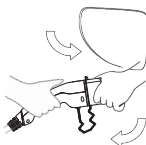
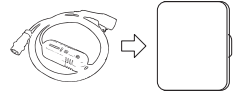



Nutzung: Ladevorgang Beenden

Ladevorgang beenden



















Schritt	Darstellung	Betrieb
1.		Ziehen Sie den Netzstecker aus der Steckdose.
2.		Trennen Sie den Ladeanschluss vom Elektrofahrzeug.
3.		Schließen Sie die Schutzabdeckung des Elektrofahrzeug-Ladeanschlusses und decken Sie die Schutzkappe des Ladesteckers ab.
4.		Verstauen Sie das Ladegerät in der Tasche.

Lichtstatusanzeige

























Lichtstatusanzeige

Anzeigeleuchte	Status	Indicator Light	Status	Indicator Light	Status
	Aus		Blinkt		Ein
	Aus		Blinkt		Ein
	Aus		Blinkt		Ein

Betrieb:

1	Betrieb aus			
2	Prüfung			
3	Standby			
4	Angeschlossen			
5	Ladevorgang			
6	Ladevorgang abgeschlossen			

Fehlerbehebung:

1	CP-Fehler			
2	Relaisfehler			
3	Überspannung/Unterspannung			
4	Überstromschutz			
5	Stromschutzschalter			
6	Nicht geerde			
7	Temperaturwarnung			
8	Dauerhaft hohe Temperatur			

Funktion: Nennstrom Wechseln

Nennstrom wechseln:



Evor Sie den Ladestrom wechseln, achten Sie bitte darauf, dass der Netzstecker richtig eingesteckt wurde und dass das andere Kabelende aus dem Elektrofahrzeug gezogen wurde.

Schritt	Darstellung	Status
1. Stecken Sie den Netzstecker in die richtige Steckdose.		Bereit
2. Halten Sie die "Amps"-Taste 2 Sekunden lang gedrückt.		Nennstromeinstellungsmodus öffnen
3. Wechseln Sie zwischen 8, 10, 13 und 16 A-Strom, indem Sie die Taste kurz drücken.		Nennstrom entsprechend den Nutzeranforderungen einstellen
4. Halten Sie die Taste erneut 2 Sekunden lang gedrückt.		Stromeinstellung erfolgreich

Schließen Sie die Einstellung in jedem Schritt bitte innerhalb von 4 Sekunden, da der Einstellungsmodus ansonsten deaktiviert wird.

Funktion: Timer



Bevor Sie die Timer-Funktion aktivieren, achten Sie bitte darauf, dass der Netzstecker richtig eingesteckt wurde und dass das andere Kabelende aus dem Elektrofahrzeug gezogen wurde.

Schritt	Darstellung	Status
1. Stecken Sie den Netzstecker in die richtige Steckdose.		Bereit
2. Halten Sie die TIME-Taste 2 Sekunden lang gedrückt.		In den Timer-Funktionseinstellungsmodus wechseln Der Timer verzögert den Start um die ausgewählte Anzahl von Stunden
3. Wechseln Sie zwischen 1, 2, 4, 6, 8 und 16 A-Strom, indem Sie die Taste kurz drücken.		Timer entsprechend den Nutzeranforderungen einstellen
4. Halten Sie die Taste erneut 2 Sekunden lang gedrückt.		Timer-Einstellung erfolgreich

Schließen Sie die Einstellung in jedem Schritt bitte innerhalb von 4 Sekunden, da der Einstellungsmodus ansonsten deaktiviert wird.

Hinweis:

Falls Sie die Timer-Funktion nach Start des Countdowns abbrechen möchten, befolgen Sie einen der folgenden Schritte:



1. Ziehen Sie den Stecker direkt aus der Wandsteckdose; oder
2. Halten Sie die TIME-Taste 5 Sekunden lang gedrückt.

EV draagbare oplader

Lees de volgende instructies aandachtig vóór het opladen van uw elektrisch voertuig, let op voor de gevaren die verbonden zijn aan elektrische kringen en de standaard praktijken voor het voorkomen van ongevallen.

Nederlands

Inhoud

Inleiding tot de draagbare Ev-oplader (Mode 2)	32
Betekenis van de indicatoren van de regelaar en technische parameters	33
Verklaring van de "  " en de "  ! " symbolen	35
Gebruik	36
Strat het opladen	36
Stoppen met opladen	37
Status verlichting van het scherm	38
Functie	39
Nominale srtoom verandering	39
Timer	40

Inleiding Tot De Draagbare Ev-oplader (Mode 2)

⚠ OPGELET

- Gebruik de voedingsbron met een externe stroomonderbreker.
- Zorg ervoor dat de oplader wordt bewaard op een veilige plaats, uit het bereik van jonge kinderen of huisdieren.
- Gebruik dit product op een koele, droge en goed geventileerde plaats; vermijd dat er water in de stekker komt.
- Open de behuizing niet tijdens het opladen of wanneer de oplader is ingeschakeld.
- Beschadig het product niet opzettelijk.

Inleiding tot de draagbare Ev-oplader (Mode 2)

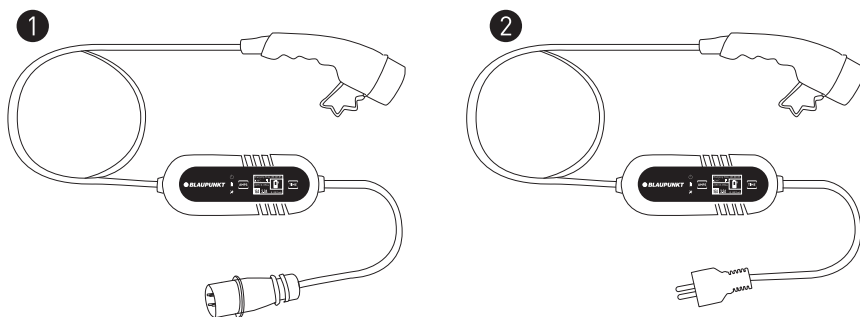

Specificaties

Model	Type voedingsspanning	Totale lengte van de kabel	Spanning	Nominale stroom	Type van aansluiting
P1PM2T2	Een-fase	8m	200-250V	8/10/13/16A	T2
P1PM2T1	Een-fase	8m	200-250V	8/10/13/16A	T1
P1PM2T2C	Een-fase	8m	200-250V	8/10/13/16A	T2
P3PM2T2	Driefase	8m	380-450V	8/10/13/16A	T2
P1PM2T2BS	Een-fase	8m	200-250V	8/10/13A	T2
P1PM2T1BS	Een-fase	8m	200-250V	8/10/13A	T1
P3P6MT2	Driefase	6m	380-450V	8/10/13/16A	T2
P1P6MT2	Een-fase	6m	200-250V	8/10/13/16A	T2
P1P6MT2L	Een-fase	6m	200-250V	8/10/13/16A	T2
P1PM2T2L	Een-fase	8m	200-250V	8/10/13/16A	T2
P1PM2T2CH	Een-fase	8m	200-250V	8/10A	T2
P1PM2T2DK	Een-fase	8m	200-250V	6A	T2

1 Model: P3PM2T2 / P3P6MT2

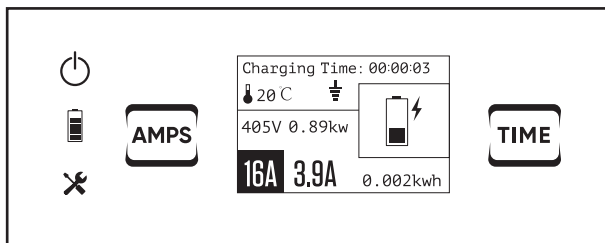

Betekenis van de indicatoren van de regelaar

	Aan/Uit	405V	Spanning
	Laden	0.89kw	Vermogen
	Indicator voor problemen	16A	Nominale stroom
	Nominale stroom veranderende knop	3.9A	Constante stroom
00:00:03	Laadtijd	0.002kwh	Elektriciteitsverbruik
	Temperatuur		Knop tijdsfunctie
	PE-detectie (aardingsdetectie)		De stroomopwaartse PE is niet gedetecteerd en het laden kan niet worden gestart.

Control box :

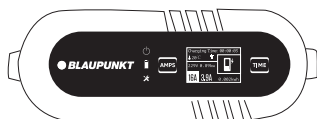

Technische parameters

Afmetingen (L x B x H)	260 x 100 x 72.5 mm
Gewicht	3-fase: 3.35 kg / 2.9 kg
Beschermingsklasse (Control box)	IP65
Bedrijfstemperatuur	-30°C tot +50°C

- 1 Model: P1PM2T2 / P1PM2T1 / P1PM2T2C / P1PM2T2BS / P1PM2T1BS
P1P6MT2 / P1P6MT2L / P1PM2T2L / P1PM2T2CH / P1PM2T2DK

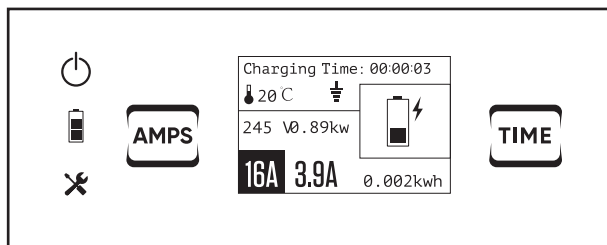

Betekenis van de indicatoren van de regelaar

	Aan/Uit	245V	Spanning
	Laden	0.89kw	Vermogen
	Indicator voor problemen	16A	Nominale stroom
AMPS	Nominale stroom veranderende knop	3.9A	Constance stroom
00:00:03	Laadtijd	0.002kwh	Elektriciteitsverbruik
	Temperatuur	TIME	Knop tijdsfunctie
	PE-detectie (aardingsdetectie)		De stroomopwaartse PE is niet gedetecteerd en het laden kan niet worden gestart.

Control box :

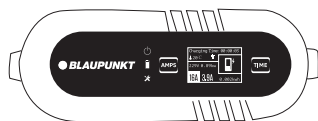

Technische parameters

Afmetingen (L x B x H)	260 x 100 x 72.5 mm
Gewicht	1-fase: 2.41 kg / 2.15 kg
Beschermingsklasse (Control box)	IP65
Bedrijfstemperatuur	-30°C tot +50°C

Verklaring van de "⚡" en de "⚡!" symbolen

Gebruikers moeten voor elk gebruik het PE-detectiemerk "⚡" op het display controleren.

1. Als de markering "⚡" op het scherm verschijnt, betekent dit dat de lader de aanwezigheid van de stroomopwaartse PE moet controleren en dat het laadproces pas begint als de stroomopwaartse PE aanwezig is.

LET OP: als de markering "⚡!" verschijnt, betekent dit dat de stroomopwaartse PE niet is gedetecteerd en het laden niet kan worden gestart.

2. Als de markering "⚡" NIET op het scherm verschijnt, betekent dit dat de lader geen functie heeft om de aanwezigheid van de stroomopwaartse PE te verifiëren, en dat er kan worden geladen, ongeacht of de PE kan worden gedetecteerd.

ATTENTIE: Het wordt sterk aanbevolen dat gebruikers onder toestand 1 laden. Toestand 2 heeft bepaalde veiligheidsrisico's door de afwezigheid van PE. Dus conditie 2 mag **alleen** worden gebruikt onder de vooronderstelling dat gebruikers de veiligheid kunnen garanderen en in speciale omstandigheden waar PE niet bestaat in het stroomsysteem.

Deactiveer PE Detectie:
Heractiveer PE Detectie:

Druk op "Ampère+Tijd" gedurende 4 seconden in.
Druk op "Ampère+Tijd" gedurende 4 seconden in.

Gebruik: Start het opladen

Start het opladen

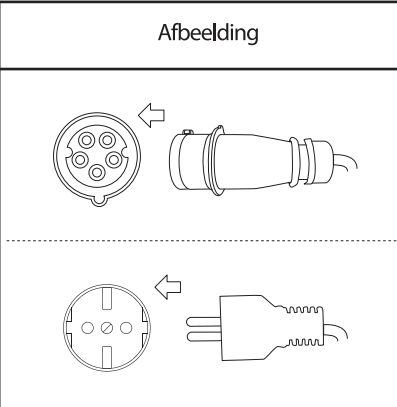
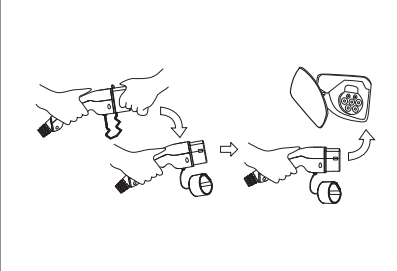
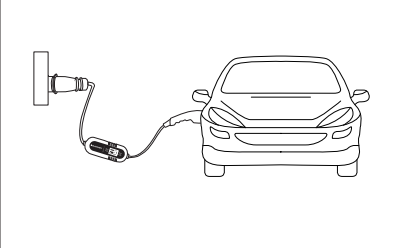
Stap	Afbeelding	Werking
1.		Steek de stekker in het juiste stopcontact.
2.		Verwijder de beschermkap en steek de laadstekker volledig in de EV-laadpoort.
3.		Start het opladen.

GEVAAR



Het product niet gebruiken als het beschadigd lijkt of als de kabel stuk is.

De stekker niet demonteren of monteren met gewijzigde interne onderdelen.

De producten niet reinigen met chemicaliën of de Ev-auto niet schoonmaken tijdens het opladen.



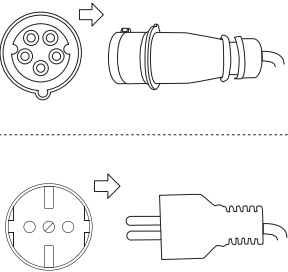
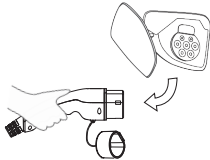
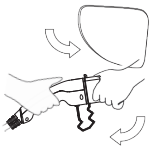





Gebruik: Stoppen met opladen

Stoppen met opladen



















Stap	Afbeelding	Werking
1.		Trek de stekker uit het stopcontact.
2.		Trek de laadstekker uit het stopcontact van het EV-voertuig.
3.		Sluit de beschermkap van de EV-laadpoort en plaats de beschermkap op de laadstekker.
4.		Steek de draagbare oplader in de zak.

Status verlichting van het scherm

























Status verlichting van het scherm

Indicatielampje	Status	Indicatielampje	Status	Indicatielampje	Status
	Uit		Knipperend		Aan
	Uit		Knipperend		Aan
	Uit		Knipperend		Aan

Bediening:

1	Uitschakelen			
2	Controleren			
3	Stand-by			
4	Aangesloten			
5	Laden			
6	Laden voltooid			

Problemen oplossen:

1	CP Fout			
2	Fout relais			
3	Overspanning/onderspanning			
4	Overstroombeveiliging			
5	Elektrische lekbeveiliging			
6	Niet geaard			
7	Temperatuurswaarschuwing			
8	Aanhoudende hoge temperatuur			

Functie: Nominale stroom verandering

Nominale stroom verandering:

OPGELET

Zorg er vóór het wijzigen van de oplaadstroom voor dat de stekken goed in het stopcontact steekt en dat de andere kabel uit het EV-voertuig is getrokken.

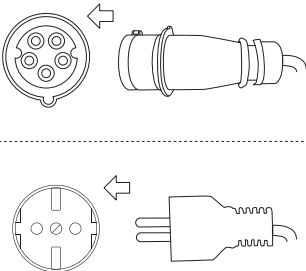
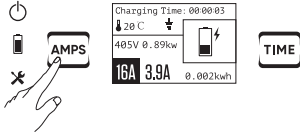
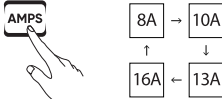
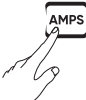
Stap	Afbeelding	Status
1. Steek de stekker in het juiste stopcontact.		Klaar
2. Houd de knop "Amps" 2 seconden ingedrukt.		De modus voor het instellen van de stroom openen
3. Schakel tussen de stromen 8, 10, 13 en 16 A door kort op de knop te drukken.		De nominale stroom instellen overeenkomstig de behoeften van de gebruiker
4. Druk opnieuw 2 seconden op de knop.		Instellen van de nominale stroom gelukt

Voltooi de instelling binnen de 4 seconden bij elke stap, anders wordt de instelmodus gedeactiveerd.

Funktion: Timer

Timerfunctie:



Zorg er vóór het activeren van de timerfunctie voor dat de stekken goed in het stopcontact steekt en dat de andere kabel uit het EV-voertuig is getrokken.

Stap	Afbeelding	Status
1. Steek de stekker in het juiste stopcontact.		Klaar
2. Houd de knop "Tijd" 2 seconden ingedrukt.		De modus voor het instellen van de timerfunctie opensen. De timer zal de start vertragen overeenkomstig het geselecteerde aantal uren
3. Schakel tussen de tijden 1, 2, 4, 6, 8 en 10 H door kort op de knop te drukken.		De timer instellen overeenkomstig de behoeften van de gebruiker
4. Druk opnieuw 2 seconden op de knop.		Timer instellen gelukt

Voltooi de instelling binnen de 4 seconden bij elke stap, anders wordt de instelmodus gedeactiveerd.



Opmerking:

Als u de timerfunctie wilt annuleren na het starten van het aftellen, kunt u een van de volgende stappen ondernemen:

1. Trek de stekker uit het stopcontact; of
2. Houd de knop Tijd 5 seconden ingedrukt.

Cargador portátil para vehículos eléctricos

Lea atentamente las instrucciones siguientes antes de cargar su vehículo eléctrico; tenga en cuenta los peligros relacionados con los circuitos eléctricos y las prácticas estandarizadas de prevención de accidentes.

Español	Contenido
Introducción al cargador portátil para vehículos eléctricos (Mode 2)	42
Significado de los indicadores del controlador y los parámetros técnicos	43
Explicación de los símbolos "  " "  "	45
Uso	46
Iniciar la carga	46
Dejar de cargar	47
Indicador de estado de luz	48
Función	49
Cambio de corriente nominal	49
temporizador	50

Introducción al cargador portátil para vehículos eléctricos (Mode 2)

⚠ PRECAUCIÓN

- Utilice una fuente de alimentación con un disyuntor externo.
- Asegúrese de que el cargador se utiliza en un lugar seguro y aislado y fuera del alcance de niños y mascotas.
- Utilice este producto en un lugar fresco, seco y bien ventilado; evite que entre agua en el enchufe.
- No abra la carcasa mientras se realiza la carga o cuando el cargador esté encendido.
- No dañe el producto de forma maliciosa.

Introducción del cargador portátil para vehículos eléctricos (Mode 2)

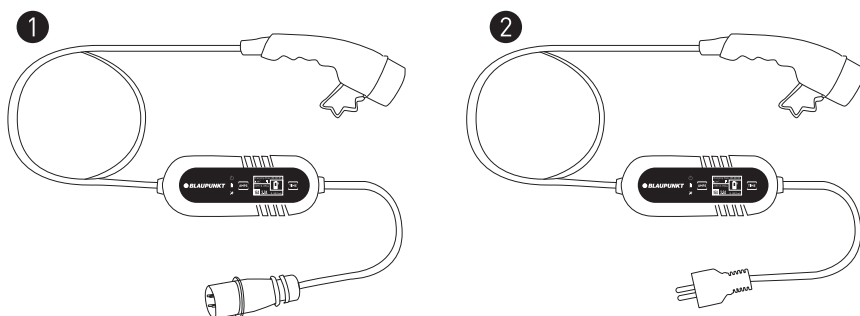

Especificaciones

Modelo	Tipo de fuente de alimentación	Longitud total del cable	Voltaje	Corriente nominal	Tipo de conector
P1PM2T2	Monofásica	8m	200-250V	8/10/13/16A	T2
P1PM2T1	Monofásica	8m	200-250V	8/10/13/16A	T1
P1PM2T2C	Monofásica	8m	200-250V	8/10/13/16A	T2
P3PM2T2	Trifásica	8m	380-450V	8/10/13/16A	T2
P1PM2T2BS	Monofásica	8m	200-250V	8/10/13A	T2
P1PM2T1BS	Monofásica	8m	200-250V	8/10/13A	T1
P3P6MT2	Trifásica	6m	380-450V	8/10/13/16A	T2
P1P6MT2	Monofásica	6m	200-250V	8/10/13/16A	T2
P1P6MT2L	Monofásica	6m	200-250V	8/10/13/16A	T2
P1PM2T2L	Monofásica	8m	200-250V	8/10/13/16A	T2
P1PM2T2CH	Monofásica	8m	200-250V	8/10A	T2
P1PM2T2DK	Monofásica	8m	200-250V	6A	T2

Significado de los indicadores del controlador y los parámetros técnicos

1 Modelo: P3PM2T2 / P3P6MT2

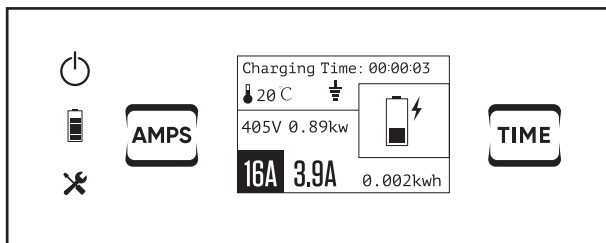

Significado de los indicadores del controlador

	Encendido/Apagado	405V	Voltaje
	Cargando	0.89kw	Potencia
	Indicador de problema	16A	Corriente nominal
	Botón de cambio de corriente nominal	3.9A	Corriente constante
00:00:03	Tiempo de carga	0.002kwh	Consumo eléctrico
	Temperatura		Botón de función de tiempo
	Detección PE (detección de tierra)		No se ha detectado el PE ascendente y no se puede iniciar la carga.

Control box :

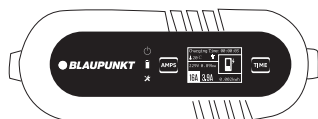

Parámetros técnicos

Dimensiones (L x A x A)	260 x 100 x 72.5 mm
Peso	Trifásica: 3.35 kg / 2.9 kg
Grado de protección(Control box)	IP65
Temperatura de funcionamiento	-30°C +50°C

Significado de los indicadores del controlador y los parámetros técnicos

- 1 Model: P1PM2T2 / P1PM2T1 / P1PM2T2C / P1PM2T2BS / P1PM2T1BS
P1P6MT2 / P1P6MT2L / P1PM2T2L / P1PM2T2CH / P1PM2T2DK

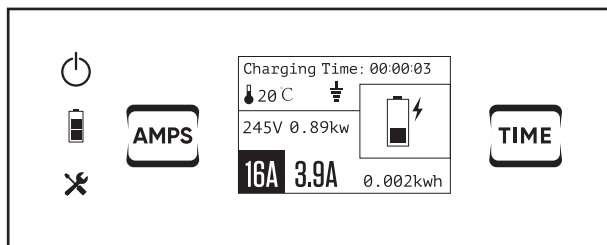

Significado de los indicadores del controlador

	Encendido/Apagado	245V	Voltaje
	Cargando	0.89kw	Potencia
	Indicador de problema	16A	Corriente nominal
	Botón de cambio de corriente nominal	3.9A	Corriente constante
00:00:03	Tiempo de carga	0.002kwh	Consumo eléctrico
	Temperatura		Botón de función de tiempo
	Detección PE (detección de tierra)		No se ha detectado el PE ascendente y no se puede iniciar la carga.

Control box :

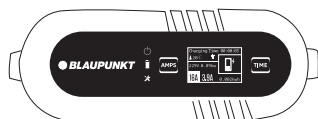

Parámetros técnicos

Dimensiones (L x A x A)	260 x 100 x 72.5 mm
Peso	Monofásica: 2.41 kg / 2.15 kg
Grado de protección(Control box)	IP65
Temperatura de funcionamiento	-30°C +50°C

Explicación de los símbolos "⚡" "⚡!"

Los usuarios deben comprobar la marca de detección PE "⚡" en la pantalla antes de cada uso. (PE significa conductor de protección)

1. Si la Marca "⚡" aparece en la pantalla, indica que el cargador deberá verificar la presencia del PE aguas arriba, y el proceso de carga sólo comenzará cuando el PE aguas arriba esté presente.

ATENCIÓN: si aparece la marca, "⚡!" significa que no se ha detectado el PE aguas arriba y no se puede iniciar la carga.

2. Si la marca "⚡" NO aparece en la pantalla, indica que el cargador no tiene ninguna función para verificar la presencia del PE aguas arriba, y se puede cargar tanto si se detecta el PE como si no.

ATENCIÓN: Se recomienda encarecidamente que los usuarios carguen en la condición 1.

La condición 2 presenta ciertos riesgos de seguridad debido a la ausencia de PE. Por tanto, la condición 2 sólo debe utilizarse bajo la premisa de que los usuarios puedan garantizar la seguridad y en circunstancias especiales en las que no exista PE en el sistema eléctrico.

Desactivar la detección de PE:

Pulse "Amperios+Tiempo" durante 4s a la vez.

Reactivar Detección PE:

Pulse "Amperios+Tiempo" durante 4s a la vez.

Uso: Iniciar la carga

Iniciar la carga

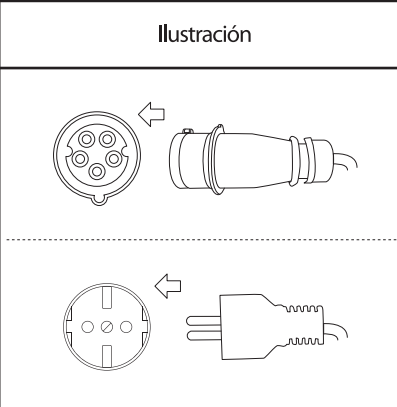
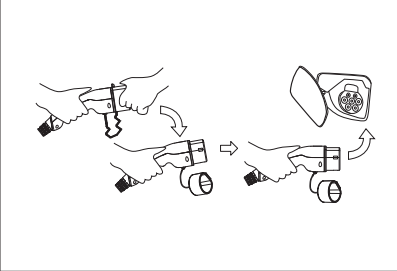
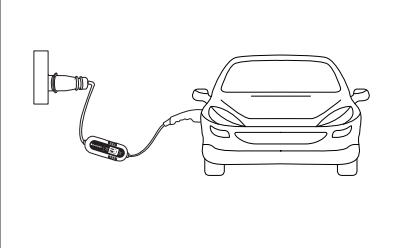
Paso	Ilustración	Funcionamiento
1.		Inserte el enchufe en la toma de corriente correcta.
2.		Retire la tapa protectora e inserte del todo el conector de carga en el puerto de carga del vehículo eléctrico.
3.		Inicie la carga.

PELIGRO

No utilice el producto si parece estar dañado o si el cable está roto.

No monte o desmonte el conector ni cambie las piezas internas.





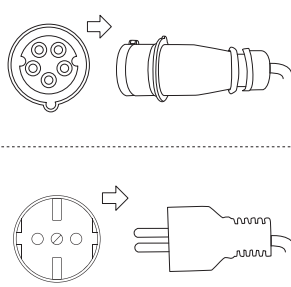
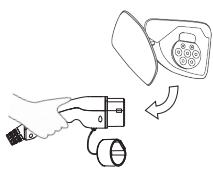
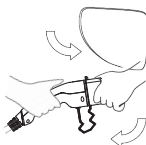
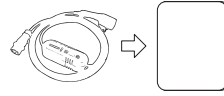



No limpie los materiales con productos químicos ni limpie el vehículo eléctrico durante la carga.

Dejar de cargar



















Paso	Ilustración	Funcionamiento
1.		Quite el enchufe de la toma de corriente.
2.		Desconecte el conector de carga del vehículo eléctrico.
3.		Cierre la carcasa protectora del puerto de carga del vehículo eléctrico y, a continuación, ponga la tapa protectora del conector de carga.
4.		Meta el cargador portátil en la bolsa.

Indicador de estado de luz

























Indicador de estado de luz

Luz indicadora	Estado	Luz indicadora	Estado	Luz indicadora	Estado
	Apagado		Parpadeante		Encendido
	Apagado		Parpadeante		Encendido
	Apagado		Parpadeante		Encendido

Funcionamiento:

1	Apagado			
2	Comprobación			
3	En espera			
4	Conectado			
5	Cargando			
6	Carga terminada			

Resolución de problemas:



1	Error de CP			
2	Error de relé			
3	Sobretensión/Baja tensión			
4	Protección contra sobrecorriente			
5	Protección contra fugas eléctricas			
6	Sin toma de tierra			
7	Advertencia de temperatura			
8	Temperatura alta persistente			

Función: Cambio de corriente nominal

Cambio de corriente nomina:

PRECAUCIÓN

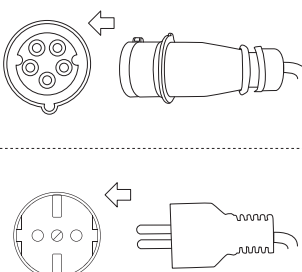
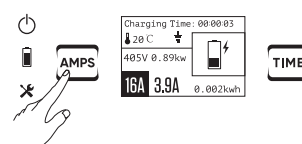
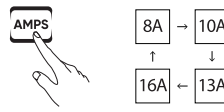
Antes de cambiar la corriente de carga, asegúrese de que el enchufe de alimentación esté firmemente insertado en la toma de corriente y que el otro extremo del cable esté desconectado del vehículo eléctrico.

Paso	Ilustración	Estado
1. Inserte el enchufe en la toma de corriente correcta.		Preparado
2. Mantenga presionado el botón "Amps" durante 2 segundos.		Acceder al modo de configuración de corriente
3. Cambie entre las corrientes de 8, 10, 13 y 16 A presionado brevemente el botón.		Establecer la corriente nominal según las necesidades del usuario
4. Presione el botón durante 2 segundos otra vez.		Configuración de corriente nominal correcta



Complete la configuración antes de 4 segundos en cada paso; de lo contrario, el modo de configuración se desactivará.

Función: temporizador

Función de temporizador:

PRECAUCIÓN

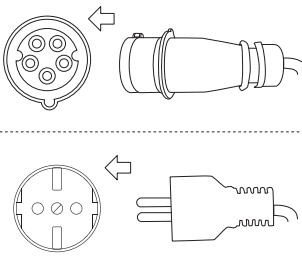
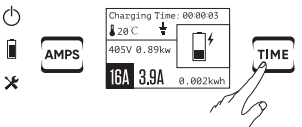
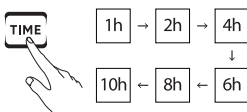
Antes de cambiar la función de temporizador, asegúrese de que el enchufe de alimentación esté firmemente insertado en la toma de corriente y que el otro extremo del cable esté desconectado del vehículo eléctrico.

Paso	Ilustración	Estado
1. Inserte el enchufe en la toma de corriente correcta.		Preparado
2. Mantenga presionado el botón "Time" (Tiempo) durante 2 segundos.		Acceder al modo de configuración de la función del temporizador. El temporizador retrasará el inicio en el número de horas seleccionado
3. Cambie entre las horas 1, 2, 4, 6, 8 y 10 H presionado brevemente el botón.		Establecer el temporizador según las necesidades del usuario
4. Presione el botón durante 2 segundos otra vez.		Configuración del temporizador correcta

Complete la configuración antes de 4 segundos en cada paso; de lo contrario, el modo de configuración se desactivará.

Nota:

Si desea cancelar la función de tiempo después de que haya comenzado la cuenta atrás, puede realizar uno de los pasos siguientes:



1. Desconecte directamente el enchufe de la toma de corriente; o bien
2. Mantenga presionado el botón "Time" (Tiempo) durante 5 segundos.

Sähköajoneuvon kannettava laturi

Lue seuraavat ohjeet huolellisesti ennen sähköajoneuvosi latausta. Huomioi virtapiireihin liittyvät vaarat ja vakiokäytännöt onnettomuuksien ehkäisemiseksi.

Suomi

Sisältö

Sähköajoneuvon kannettavan laturin esittely (Mode 2)	52
Ohjainmerkkivalojen ja teknisten parametrien merkitys	53
Symbolien selitys "  " "  "	55
Käyttö	56
Aloita lataus	56
Lopeta lataus	57
Tilavalojen näyttö	58
Toiminto	59
Nimellisvirta muuttuu	59
Timer (Ajastin)	60

Sähköajoneuvon kannettavan laturin esittely (Mode 2)

! HUOMIO

- Käytä virtalähdettä, jossa on ulkoinen virrankatkaisin.
- Varmista, että laturia käytetään turvallisessa ja varmassa paikassa poissa lasten tai lemmikkien ulottuvilta.
- Käytä tuotetta viileässä, kuivassa ja hyvin tuulettussa tilassa. Vältä veden pääsyä pistokkeeseen.
- Älä avaa koteloa ladattaessa tai laturi kytkeytyy päälle.
- Älä vahingoita tuotetta tahallisesti.

Sähköajoneuvon kannettavan laturin esittely (Mode 2)

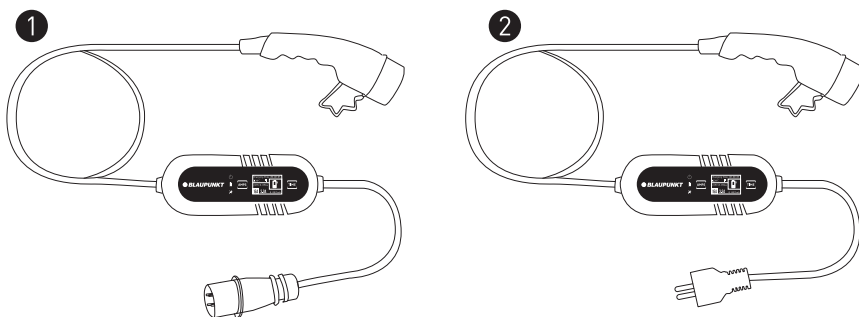

Tekniset tiedot

Malli	Tehosyöttötyyppi	Kaapelin kokonaispituus	Jännite	Nimellisvirta	Liitintyyppi
P1PM2T2	Yksivaihe	8m	200-250V	8/10/13/16A	T2
P1PM2T1	Yksivaihe	8m	200-250V	8/10/13/16A	T1
P1PM2T2C	Yksivaihe	8m	200-250V	8/10/13/16A	T2
P3PM2T2	Kolmivaihe	8m	380-450V	8/10/13/16A	T2
P1PM2T2BS	Yksivaihe	8m	200-250V	8/10/13A	T2
P1PM2T1BS	Yksivaihe	8m	200-250V	8/10/13A	T1
P3P6MT2	Kolmivaihe	6m	380-450V	8/10/13/16A	T2
P1P6MT2	Yksivaihe	6m	200-250V	8/10/13/16A	T2
P1P6MT2L	Yksivaihe	6m	200-250V	8/10/13/16A	T2
P1PM2T2L	Yksivaihe	8m	200-250V	8/10/13/16A	T2
P1PM2T2CH	Yksivaihe	8m	200-250V	8/10A	T2
P1PM2T2DK	Yksivaihe	8m	200-250V	6A	T2

Ohjainmerkkivalojen ja teknisten parametrien merkitys

1 Malli: P3PM2T2 / P3P6MT2

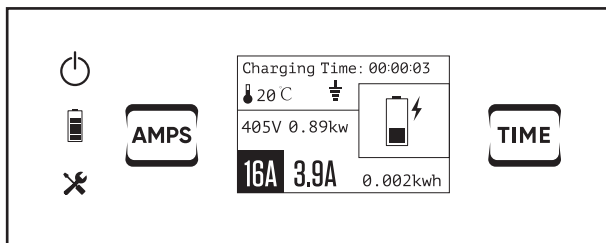

Ohjainmerkkivalojen merkitys

	Virta päällä / pois	405V	Jännite
	päältä	0.89kw	Power (Virta)
	Latautuu Vian merkkivalo	16A	Nimellisvirta
	Nimellisvirta muuttuupainike	3.9A	Vakiovirta
00:00:03	Latausaika	0.002kwh	Sähkönkulutus
	Lämpötila		Aikatoimintopainike
	PE-tunnistus (maadoituksen tunnistus)		Ylävirran PE:tä ei ole havaittu, eikä latausta voida käynnistää.

Control box :

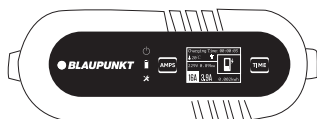

Tekniset parametrit

Mitat (P x L x K)	260 x 100 x 72.5 mm
Paino	Kolmivaihe: 3.35 kg / 2.9 kg
IP-luokitus(Control box)	IP65
Käyttölämpötila	-30°C +50°C

Ohjainmerkkivalojen ja teknisten parametrien merkitys

- 1 Model: P1PM2T2 / P1PM2T1 / P1PM2T2C / P1PM2T2BS / P1PM2T1BS
P1P6MT2 / P1P6MT2L / P1PM2T2L / P1PM2T2CH / P1PM2T2DK

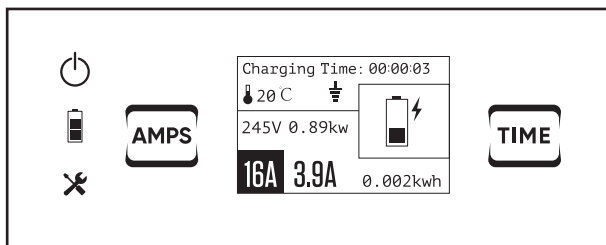

Ohjainmerkkivalojen merkitys

	Virta päällä / pois	245V	Jännite
	päältä	0.89kw	Power (Virta)
	Latautuu Vian merkkivalo	16A	Nimellisvirta
	Nimellisvirta muuttuupainike	3.9A	Vakiovirta
00:00:03	Latausaika	0.002kwh	Sähkönkulutus
	Lämpötila		Aikatoimintopainike
	PE-tunnistus (maadoituksen tunnistus)		Ylävirran PE:tä ei ole havaittu, eikä latausta voida käynnistää.

Control box :

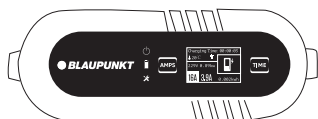

Tekniset parametrit

Mitat (P x L x K)	260 x 100 x 72.5 mm
Paino	Yksivaihe: 2.41 kg / 2.15 kg
IP-luokitus(Control box)	IP65
Käyttölämpötila	-30°C +50°C

Symbolien selitys "⏻" "⏻!"

Käyttäjien on tarkistettava näytössä oleva PE-tunnistusmerkki "⏻" ennen jokaista käyttökertaa. (PE tarkoittaa suojajohdinta)

1.Jos merkki "⏻" näkyy näytössä, se osoittaa, että laturin on tarkistettava edeltävän PE:n läsnäolo, ja latausprosessi alkaa vasta, kun edeltävä PE on läsnä.

HUOMIO: jos merkki "⏻!" näkyy, se tarkoittaa, että ylävirran PE:tä ei ole havaittu eikä latausta voida aloittaa.

2.Jos merkkiä "⏻" EI näy näytössä, se tarkoittaa, että laturilla ei ole toimintoa, jolla voidaan tarkistaa ylävirran PE:n läsnäolo, ja se voidaan ladata riippumatta siitä, voidaanko PE havaita vai ei.

HUOMIO: On erittäin suositeltavaa, että käyttäjät lataavat olosuhteissa 1.

Tilassa 2 on tiettyjä turvallisuusriskejä PE:n puuttumisen vuoksi. Siksi ehtoa 2 tulisi käyttää vain sillä edellytyksellä, että käyttäjät voivat varmistaa turvallisuuden, ja erityisolosuhteissa, joissa PE:tä ei ole sähköjärjestelmässä.

PE-tunnistuksen poistaminen käytöstä : Paina "Amps+Time" -näppäintä 4 sekunnin ajan samanaikaisesti.

Aktivoi PE-tunnistus uudelleen: Paina "Amps+Time" 4 sekunnin ajan samanaikaisesti.

Käyttö: Aloita lataus

Aloita lataus

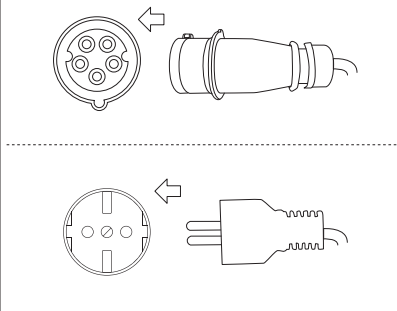
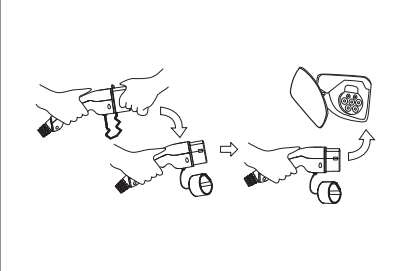
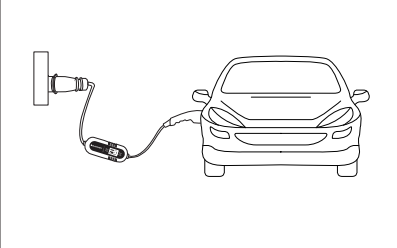
Vaihe	Kuva	Käyttö
1.		Laita pistoke oikean tehonsyötön pistorasiaan.
2.		Irrota suojatulppa ja laita latausliitin kokonaan sähköajoneuvon latausporttiin.
3.		Aloita lataus.



VAARA

Älä käytä tuotetta, jos se vaikuttaa vahingoittuneelta tai kaapeli on hajonnut.

Älä pura tai kokoa liitintä tai vaihda sisäisiä osia.



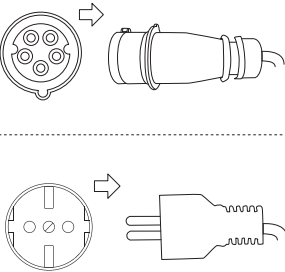
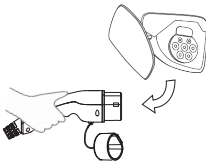
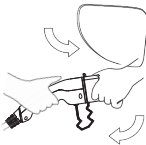

Älä puhdistu tuotteita kemikaaleilla tai puhdistu sähköajoneuvoa latauksen aikana.

Lopeta lataus



















Vaihe	Kuva	Käyttö
1.		Irrota pistoke tehonsyötön pistorasiasta.
2.		Irrota latausliitin sähköajoneuvosta.
3.		Sulje sähköajoneuvon latausportin suojus ja peitä sitten latausliittimen suojatulppa.
4.		Laita kannettava laturi pussiin.

Tilavalojen näyttö

























Tilavalojen näyttö

Merkkivalo	Tila	Merkkivalo	Tila	Merkkivalo	Tila
	Off (Pois)		Vilkkuu		On (Päällä)
	Off (Pois)		Vilkkuu		On (Päällä)
	Off (Pois)		Vilkkuu		On (Päällä)

Käyttö:

1	Virta pois			
2	Tarkistus			
3	Valmiustila			
4	Liitetty			
5	Latautuu			
6	Lataus valmis			

Vianetsintä:



1	CP-virhe			
2	Relevirhe			
3	Ylijännite/alijännite			
4	Ylivirtasuojaus			
5	Sähkövuotosuojaus			
6	Ei maadoitettu			
7	Lämpötilavaroitus			
8	Jatkuva korkea lämpötila			

Toiminto: Nimellisvirta muuttuu

Nimellisvirta muuttuu:

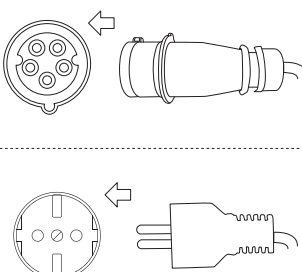
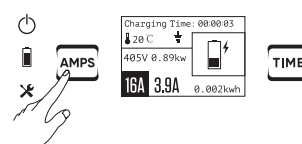
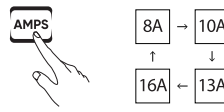

Varmista ennen latausvirran vaihtamista, että pistoke on laitettu kunnolla pistorasiaan ja että kaapelin toinen pää on irrotettu sähköajoneuvosta.

Vaihe	Kuva	Tila
1. Laita pistoke oikean tehonsyötön pistorasiaan.		Valmis
2. Pidä Amps-painike painettuna 2 sekuntia.		Virta-asetustilan syöttäminen
3. Vaihtele 8, 10, 13 ja 16 A:n virtojen välillä painamalla painiketta lyhyesti.		Nimellisvirtan asettaminen käyttäjän tarpeiden mukaan
4. Paina painiketta 2 sekuntia uudelleen.		Nimellisvirta -asetus valmis

Tee asetus loppuun 4 sekunnin kuluessa jokaisessa vaiheessa. Muussa tapauksessa asetustilan aktivointi loppuu.

Toiminto: Timer (Ajastin)

Ajastintoiminto:



HUOMIO

Varmista ennen ajastintoiminnon aktivointia, että pistoke on laitettu kunnolla pistorasiaan ja että kaapelin toinen pää on irrotettu sähköajoneuvosta.

Vaihe	Kuva	Tila
1. Laita pistoke oikean tehonsyötön pistorasiaan.		Valmis
2. Pidä Time (Aika) -painike painettuna 2 sekuntia.		Ajastintoiminnon asetustilan syöttäminen. Ajastin viivästää latauksen aloittamista valitulla tuntimäärällä
3. Vaihtele 1, 2, 4, 6, 8 ja 10 tunnin välillä painamalla painiketta lyhyesti.		Ajastimen asettamisen käyttäjän tarpeiden mukaan
4. Paina painiketta 2 sekuntia uudelleen.		Ajastimen asetus valmis

Tee asetus loppuun 4 sekunnin kuluessa jokaisessa vaiheessa. Muussa tapauksessa asetustilan aktivointi loppuu.

Huomaa:



Jos haluat peruuttaa Ajastintoiminnon, kun laskuri on alkanut laskea alaspäin, voit tehdä jonkun seuraavista vaiheista:

1. Irrota pistoke pistorasiasta suoraan tai
2. Paina Ajastinpainiketta 5 sekuntia.

Chargeur portable de véhicule électrique (EV)

Veuillez lire attentivement les instructions suivantes avant de charger votre véhicule électrique. Soyez conscient des dangers liés aux circuits électriques et des pratiques courantes de prévention des accidents.

Français	Contenu
----------	---------

Introduction au chargeur portable de véhicule électrique (EV) (mode 2)	62
Signification des indicateurs du contrôleur et des paramètres techniques	63
Explication des symbols "  " "  ! "	65
Utilisation	66
Iniciar la carga	66
Arrêt de la charge	67
Affichage de l'état de l'indicateur	68
Fonction	69
Changement de courant nominal	69
Minuterie	70

Introduction au chargeur portable de véhicule électrique (EV) (mode 2)

⚠ ATTENTION

- Utiliser la source d'alimentation avec un disjoncteur externe.
- S'assurer que le chargeur est utilisé dans un endroit sûr et sécurisé, hors de portée des jeunes enfants ou des animaux.
- Veuillez utiliser ce produit dans un endroit frais, sec et bien ventilé ; éviter la pénétration de l'eau dans la prise.
- Ne pas ouvrir le boîtier pendant la charge ou lorsque le chargeur est sous tension.
- Ne pas abîmer malicieusement le produit.

Introduction au chargeur portable de véhicule électrique (EV) (mode 2)

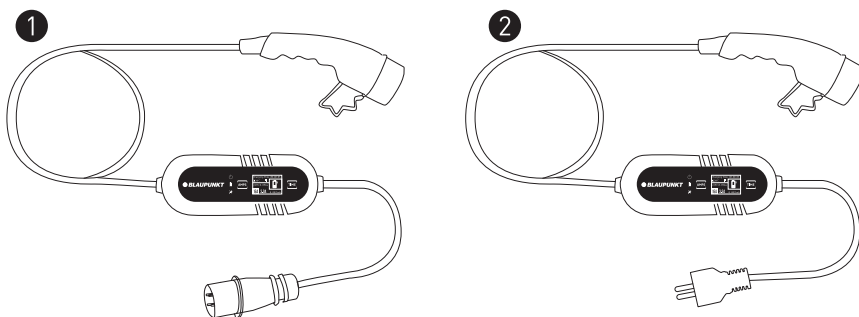

Spécifications

Modèle	Type d'alimentation électrique	Longueur totale du câble	Tension	Courant nominal	Type de connecteur
P1PM2T2	Monophasé	8m	200-250V	8/10/13/16A	T2
P1PM2T1	Monophasé	8m	200-250V	8/10/13/16A	T1
P1PM2T2C	Monophasé	8m	200-250V	8/10/13/16A	T2
P3PM2T2	Triphasé	8m	380-450V	8/10/13/16A	T2
P1PM2T2BS	Monophasé	8m	200-250V	8/10/13A	T2
P1PM2T1BS	Monophasé	8m	200-250V	8/10/13A	T1
P3P6MT2	Triphasé	6m	380-450V	8/10/13/16A	T2
P1P6MT2	Monophasé	6m	200-250V	8/10/13/16A	T2
P1P6MT2L	Monophasé	6m	200-250V	8/10/13/16A	T2
P1PM2T2L	Monophasé	8m	200-250V	8/10/13/16A	T2
P1PM2T2CH	Monophasé	8m	200-250V	8/10A	T2
P1PM2T2DK	Monophasé	8m	200-250V	6A	T2

1 Modèle: P3PM2T2 / P3P6MT2

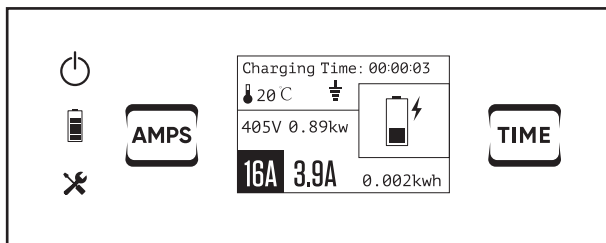

Signification des indicateurs du contrôle

	Marche/Arrêt	405V	Tension
	En charge	0.89kw	Puissance
	Indicateur de défectuosité	16A	Courant nominal
	Bouton de changement de courant nomina	3.9A	Courant constant
00:00:03	Temps de charge	0.002kwh	Consommation électrique
	Température		Bouton de fonction « Time » (Durée)
	Détection PE (détection de mise à la terre)		L'EP en amont n'a pas été détecté et la charge ne peut pas être lancée.

Control box :

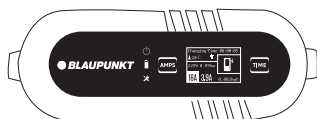

Paramètre technique

Dimension (Longueur x Largeur x Hauteur)	260 × 100 × 72.5 mm
Poids	Triphasé : 3.35 kg / 2.9 kg
Degré de protection(Control box)	IP65
Température de fonctionnement	-30°C C à +50°C

Signification des indicateurs du contrôleur et des paramètres techniques

- 1 Modèle: P1PM2T2 / P1PM2T1 / P1PM2T2C / P1PM2T2BS / P1PM2T1BS
P1P6MT2 / P1P6MT2L / P1PM2T2L / P1PM2T2CH / P1PM2T2DK

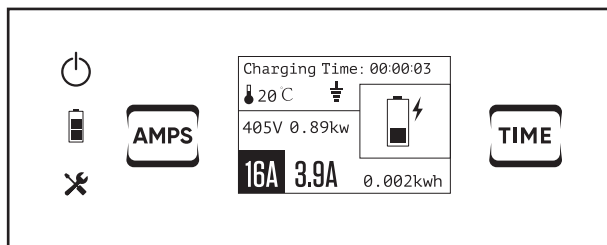

Signification des indicateurs du contrôle

	Marche/Arrêt	245V	Tension
	En charge	0.89kw	Puissance
	Indicateur de défectuosité	16A	Courant nominal
AMPS	Bouton de changement de courant nomina	3.9A	Courant constant
00:00:03	Temps de charge	0.002kwh	Consommation électrique
20 C	Température	TIME	Bouton de fonction « Time » (Durée)
	Détection PE (détection de mise à la terre)		L'EP en amont n'a pas été détecté et la charge ne peut pas être lancée.

Control box :

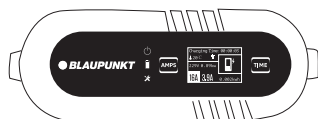

Paramètre technique

Dimension (Longueur x Largeur x Hauteur)	260 × 100 × 72.5 mm
Poids	Monophasé : 2.41 kg / 2.15 kg
Degré de protection(Control box)	IP65
Température de fonctionnement	-30°C C à +50°C

Explication des symboles "⚡" "⚡!"

Les utilisateurs doivent vérifier la marque de détection PE "⚡" sur l'écran avant chaque utilisation. (PE signifie conducteur de protection)

1. Si la marque "⚡" s'affiche à l'écran, cela indique que le chargeur doit vérifier la présence du PE en amont, et que le processus de charge ne commencera que si le PE en amont est présent.

ATTENTION : si la marque "⚡!" apparaît, cela signifie que le conducteur de protection en amont n'a pas été détecté et que la charge ne peut pas commencer.

2. Si la marque "⚡" n'est PAS affichée à l'écran, cela signifie que le chargeur n'a pas la fonction de vérifier la présence du PE en amont et qu'il peut être chargé, que le PE puisse être détecté ou non.

ATTENTION : Il est fortement recommandé aux utilisateurs de charger dans la condition 1.

La condition 2 présente certains risques de sécurité en raison de l'absence de PE. La condition 2 ne doit donc être utilisée que si les utilisateurs peuvent garantir la sécurité et dans des circonstances particulières où il n'y a pas de PE dans le réseau électrique.

Désactiver la détection de PE : Appuyer simultanément sur "Amps+Time" pendant 4s.

Réactiver la détection de PE : Appuyer simultanément sur "Amps+Time" pendant 4s.

Utilisation : Démarrage de la charge

Démarrage de la charge

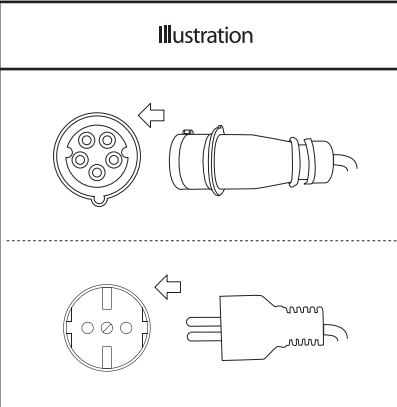
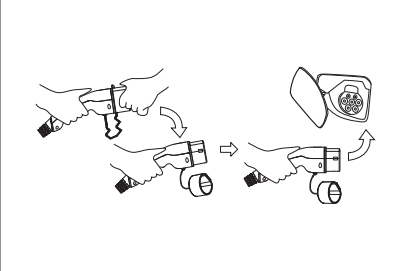
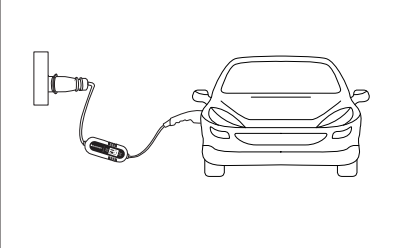
Étape	Illustration	Opération
1.		Insérez la fiche dans la bonne prise d'alimentation.
2.		Retirez le capuchon de protection et insérez complètement le connecteur de charge dans le port de charge de véhicule électrique (EV).
3.		Commencez à charger



DANGER

Ne pas utiliser le produit s'il semble endommagé ou si le câble est rompu.

Ne pas démonter ou assembler le connecteur et changer les pièces internes.



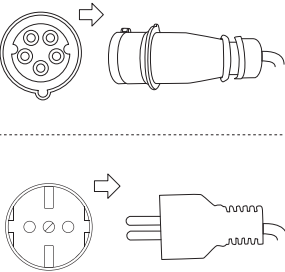
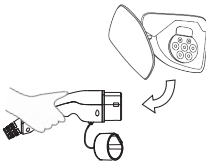
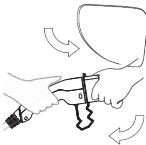





Ne pas nettoyer les produits avec des produits chimiques et ne pas nettoyer la voiture électrique pendant la charge.

Arrêt de la charge



















Étape	Illustration	Opération
1.		Débranchez la fiche de la prise d'alimentation.
2.		Débranchez le connecteur de charge du véhicule électrique (EV).
3.		Fermez la coque protectrice du port de charge (EV), puis recouvrez le capuchon de protection du connecteur de charge.
4.		Mettez le chargeur portable dans le sac

Affichage de l'état de l'indicateur

























Affichage de l'état de l'indicateur

Voyant de l'indicateur	Statut	Voyant de l'indicateur	Statut	Voyant de l'indicateur	Statut
	Arrêt		Clignotant		Marche
	Arrêt		Clignotant		Marche
	Arrêt		Clignotant		Marche

Fonctionnement:

1	Arrêt			
2	Contrôle			
3	Veille			
4	Connecté			
5	En charge			
6	Charge complète			

Dépannage:



1	Erreur CP			
2	Erreur relais			
3	Surtension/sous-tension			
4	Protection contre les surintensités			
5	Protection contre les fuites électriques			
6	Non mis à la terre			
7	Avertissement de température			
8	Température élevée persistante			

Fonction : Changement de courant nominal

Changement de courant nominal :

ATTENTION

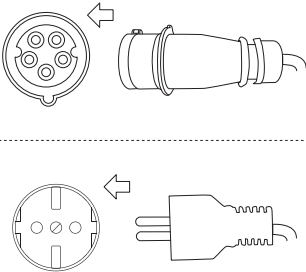
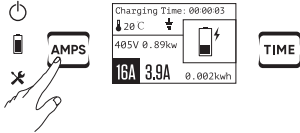
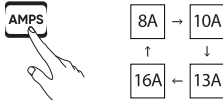
Avant de changer le courant de charge, assurez-vous que la fiche d'alimentation est fermement insérée dans la prise et que l'autre extrémité du câble est déconnectée du véhicule électrique (EV).

Étape	Illustration	Statut
1. Insérez la fiche dans la bonne prise d'alimentation.		Prêt
2. Maintenez le bouton « Amps » enfoncé pendant 2 secondes.		Accès au mode Paramètres courant
3. Basculez entre les courants 8, 10, 13 et 16 A en appuyant brièvement sur le bouton.		Réglage du courant nominal selon les besoins de l'utilisateur
4. Appuyez à nouveau sur le bouton pendant 2 secondes.		Réglage du courant nominal réussi

Veuillez effectuer le réglage en 4 secondes à chaque étape, autrement, le mode de réglage sera désactivé.

Fonction : Minuterie

Fonction minuterie :



Avant d'activer la fonction minuterie, assurez-vous que la fiche d'alimentation est fermement insérée dans la prise et que l'autre extrémité du câble est déconnectée du véhicule électrique (EV).

Étape	Illustration	Statut
1. Insérez la fiche dans la bonne prise d'alimentation.		Prêt
2. Maintenez le bouton « Time » (Durée) enfoncé pendant 2 secondes.		Accès au mode Paramètres de la fonction minuterie. La minuterie retardera le démarrage en fonction du nombre d'heures sélectionné.
3. Basculez entre les durées 1, 2, 4, 6, 8 et 10 H en appuyant brièvement sur le bouton.		Réglage de la minuterie selon les besoins de l'utilisateur.
4. Appuyez à nouveau sur le bouton pendant 2 secondes.		Réglage de la minuterie réussie.

Veuillez effectuer le réglage en 4 secondes à chaque étape, autrement, le mode de réglage sera désactivé.



Remarque:

Si vous souhaitez annuler la fonction « Time » (Durée) après le début du compte à rebours, vous pouvez suivre l'une des étapes suivantes :

1. Débrancher directement la fiche de la prise de courant ; ou
2. Appuyez sur le bouton « Time » (Durée) pendant 5 secondes.

Caricabatterie portatile EV

Leggere attentamente le seguenti istruzioni prima di caricare il veicolo elettrico, è necessario essere consapevoli dei rischi legati agli impianti elettrici e alle pratiche standard per la prevenzione degli incidenti.

Italiano	Indice
Introduzione al caricatore portatile EV (Mode 2)	72
Significato delle spie del controller e dei parametri tecnici	73
Spiegazione dei simboli "  " "  ! "	75
Uso	76
Avvio della ricarica	76
Interruzione della ricarica	77
Visualizzazione della spia di stato	78
Funzione	79
Modifica della corrente nominale	79
Timer	80

Introduzione al caricatore portatile EV (Mode 2)

⚠ CAUTELA

- Utilizzare la fonte di alimentazione con un interruttore di circuito esterno.
- Assicurarsi che il caricatore venga utilizzato in un luogo sicuro e fuori dalla portata di bambini e animali domestici.
- Utilizzare questo prodotto in un luogo fresco, asciutto e ben ventilato; evitare che entri acqua nella presa.
- Non aprire il corpo dell'apparecchio durante la ricarica o quando il caricabatterie è acceso.
- Non danneggiare intenzionalmente il prodotto.

Introduzione al caricatore portatile EV (Mode 2)

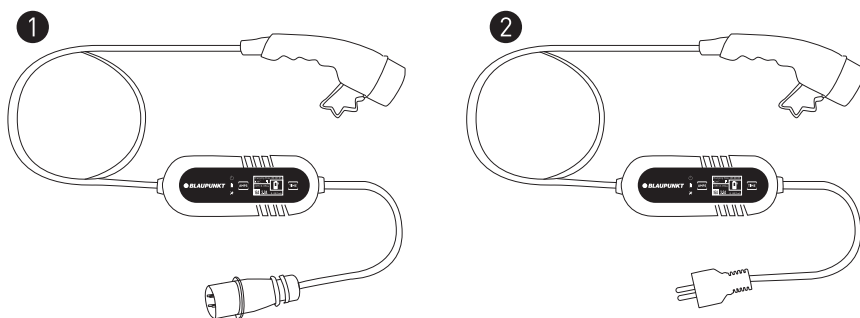

Caratteristiche

Modello	Tipo di aliment. elettrica	Lunghezza totale del cavo	Tensione	Corrente nominale	Tipo di connettore
P1PM2T2	Monofase	8m	200-250V	8/10/13/16A	T2
P1PM2T1	Monofase	8m	200-250V	8/10/13/16A	T1
P1PM2T2C	Monofase	8m	200-250V	8/10/13/16A	T2
P3PM2T2	Trifase	8m	380-450V	8/10/13/16A	T2
P1PM2T2BS	Monofase	8m	200-250V	8/10/13A	T2
P1PM2T1BS	Monofase	8m	200-250V	8/10/13A	T1
P3P6MT2	Trifase	6m	380-450V	8/10/13/16A	T2
P1P6MT2	Monofase	6m	200-250V	8/10/13/16A	T2
P1P6MT2L	Monofase	6m	200-250V	8/10/13/16A	T2
P1PM2T2L	Monofase	8m	200-250V	8/10/13/16A	T2
P1PM2T2CH	Monofase	8m	200-250V	8/10A	T2
P1PM2T2DK	Monofase	8m	200-250V	6A	T2

Significato delle spie del controller e dei parametri tecnici

1 Modello: P3PM2T2 / P3P6MT2

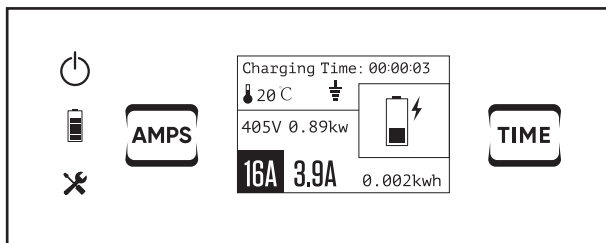

Significato delle spie della centralina

	Accensione/Spengimento	405V	Tensione
	Ricarica in corso	0.89kw	Potenza
	Spia di guasto	16A	Corrente nominale
	Pulsante di modifica della corrente nominale	3.9A	Corrente costante
00:00:03	Tempo di ricarica	0.002kwh	Consumo elettrico
	Temperatura		Tasto funzione tempo
	Rilevamento PE (rilevamento della messa a terra)		Il PE a monte non è stato rilevato e la carica non può essere avviata.

Control box :

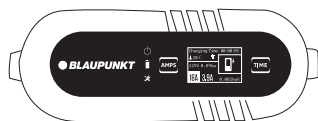

Parametri tecnici

Dimensioni (L x P x H)	260 x 100 x 72.5 mm
Peso	Trifase: 3.35 kg / 2.9 kg
Grado di protezione (Control box)	IP65
Temperatura d'esercizio	-30°C ~ +50°C

Significato delle spie del controller e dei parametri tecnici

- 1 Modello: P1PM2T2 / P1PM2T1 / P1PM2T2C / P1PM2T2BS / P1PM2T1BS
P1P6MT2 / P1P6MT2L / P1PM2T2L / P1PM2T2CH / P1PM2T2DK

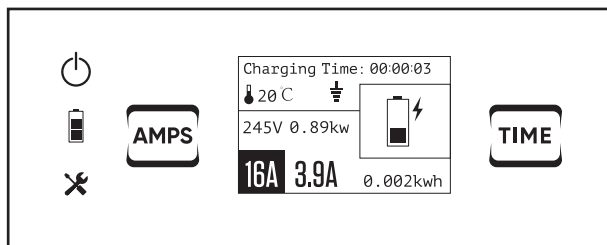

Significato delle spie della centralina

	Accensione/Spegnimento	245V	Tensione
	Ricarica in corso	0.89kw	Potenza
	Spia di guasto	16A	Corrente nominale
	Pulsante di modifica della corrente nominale	3.9A	Corrente costante
00:00:03	Tempo di ricarica	0.002kwh	Consumo elettrico
	Temperatura		Tasto funzione tempo
	Rilevamento PE (rilevamento della messa a terra)		Il PE a monte non è stato rilevato e la carica non può essere avviata.

Control box :

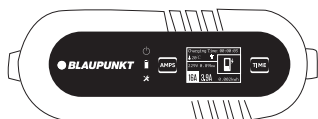

Parametri tecnici

Dimensioni (L x P x H)	260 x 100 x 72.5 mm
Peso	Monofase: 2.41 kg / 2.15 kg
Grado di protezione (Control box)	IP65
Temperatura d'esercizio	-30°C ~ +50°C

Spiegazione dei simboli "⚡" "⚡!"

Gli utenti devono controllare il marchio di rilevamento PE "⚡" sul display prima di ogni utilizzo. (PE significa conduttore protettivo)

1. Se il marchio "⚡" viene visualizzato sullo schermo, significa che il caricabatterie deve verificare la presenza del PE a monte e che il processo di carica inizierà solo quando il PE a monte è presente.

ATTENZIONE: se appare "⚡!" il contrassegno, significa che il PE a monte non è stato rilevato e la carica non può essere avviata.

2. Se il segno "⚡" NON viene visualizzato sullo schermo, significa che il caricabatterie non ha la funzione di verificare la presenza del PE a monte e può essere caricato indipendentemente dal fatto che il PE venga rilevato o meno.

ATTENZIONE: Si raccomanda vivamente agli utenti di effettuare la ricarica in base alla condizione 1. La condizione 2 presenta alcuni rischi per la sicurezza dovuti all'assenza del PE. Pertanto, la condizione 2 deve essere utilizzata solo a condizione che l'utente possa garantire la sicurezza e in circostanze particolari in cui il PE non è presente nel sistema di alimentazione.

Disattivare il rilevamento PE:

premere contemporaneamente
"Amps+Time" per 4s.

Riattivazione del rilevamento PE:

Premere contemporaneamente
"Amps+Time" per 4s.

Uso: Avvio della ricarica

Avvio della ricarica

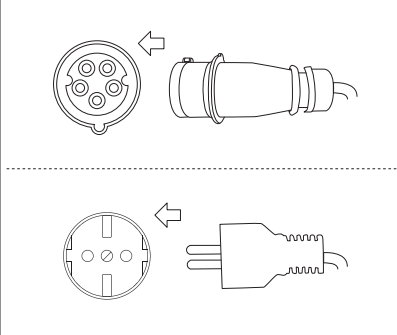
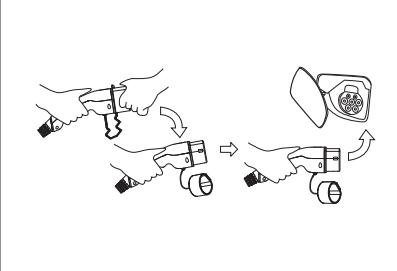
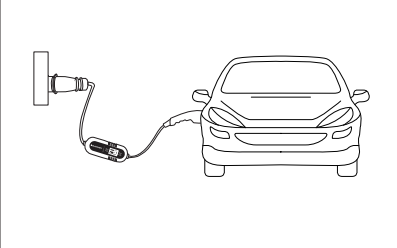
Fase	Illustrazione	Funzionamento
1.		Inserire la spina nella presa di corrente elettrica.
2.		Rimuovere il cappuccio protettivo e inserire completamente il connettore di ricarica nella porta di ricarica del veicolo elettrico.
3.		Avvio della ricarica.

PERICOLO

Non utilizzare il prodotto se è visibilmente danneggiato o se il cavo è guasto.

Non smontare o montare il connettore e non sostituire parti interne.





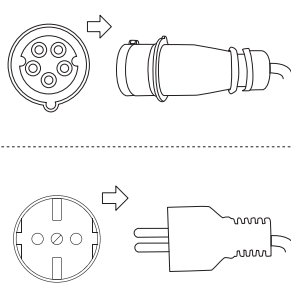
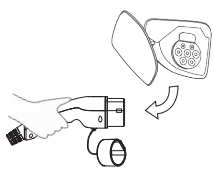
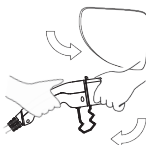
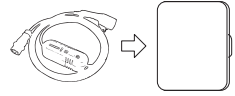



Non pulire i prodotti utilizzando sostanze chimiche o pulire l'auto elettrica durante la ricarica.

Interruzione della ricarica



















Fase	Illustrazione	Funzionamento
1.		Scollegare la spina dalla presa di corrente elettrica.
2.		Scollegare il connettore di ricarica dal veicolo EV.
3.		Chiudere l'involucro protettivo della porta di ricarica EV, quindi coprire il cappuccio protettivo del connettore di ricarica.
4.		Mettere il caricatore portatile nel sacchetto.

Visualizzazione della spia di stato

























Visualizzazione della spia di stato

Spie	Stato	Spie	Stato	Spie	Stato
	Spento		Lampeggiante		Acceso
	Spento		Lampeggiante		Acceso
	Spento		Lampeggiante		Acceso

Funzionamento:

1	Spegnimento			
2	Controllo			
3	Standby			
4	Collegato			
5	Ricarica in corso			
6	Ricarica completa			

Risoluzione dei problemi:

1	Errore CP			
2	Errore del relè			
3	Sovratensione/sottotensione			
4	Protezione da sovracorrente			
5	Protezione da perdite elettriche			
6	Non messo a terra			
7	Avvertenza temperatura			
8	Temperatura elevata persistente			

Funzione: Modifica della corrente nominale

Modifica della corrente nominale:



Prima di commutare la corrente di carica, assicurarsi che la spina di alimentazione sia inserita saldamente nella presa e che l'altra estremità del cavo sia scollegata dal veicolo EV.

Fase	Illustrazione	Stato
1. Inserire la spina nella presa di corrente elettrica.		Pronto
2. Tenere premuto il pulsante "Amps" per 2 secondi.		Entrare in modalità impostazioni di corrente
3. Passare tra le correnti a 8, 10, 13 e 16 A premendo brevemente il pulsante.		Impostare la corrente nominale in base alle necessità dell'utente
4. Premere nuovamente il pulsante per 2 secondi.		Impostazione di corrente nominale riuscita

Completare l'impostazione entro 4 secondi ad ogni passaggio, altrimenti la modalità di impostazione verrà disattivata.

Funzione: Timer

Funzione timer:



Prima di attivare la funzione timer, assicurarsi che la spina di alimentazione sia inserita saldamente nella presa e che l'altra estremità del cavo sia scollegata dal veicolo EV.

Fase	Illustrazione	Stato
1. Inserire la spina nella presa di corrente elettrica.		Pronto
2. Tenere premuto il pulsante "Time" per 2 secondi.		Entrare in modalità impostazioni funzione timer. Il timer ritarderà l'avvio del numero di ore selezionato
3. Passare tra le 1, 2, 4, 6, 8 e 10 H premendo brevemente il pulsante.		Impostare il Timer in base alle necessità dell'utente
4. Premere nuovamente il pulsante per 2 secondi.		Impostazione del timer riuscita

Completare l'impostazione entro 4 secondi ad ogni passaggio, altrimenti la modalità di impostazione verrà disattivata.





Nota:

Se si desidera annullare la funzione Tempo dopo l'inizio del conto alla rovescia, è possibile eseguire una delle seguenti operazioni:

1. Scollegare direttamente la spina dalla presa di corrente; o
2. Tenere premuto il pulsante Time per 5 secondi.

Przenośna ładowarka do pojazdów elektrycznych

Przed naładowaniem pojazdu elektrycznego należy starannie przeczytać poniższe wskazówki, pamiętać o zagrożeniach związanych z obwodami elektrycznymi oraz standardowych praktykach zapobiegania wypadkom.

Wprowadzenie do przenośnej ładowarki do pojazdów elektrycznych (Mode 2)	82
Parametry techniczne i znaczenie wskaźników kontrolera	83
Objaśnienie symboli "  " "  ! " "  ! " "  ! "	85
Użytkowanie	86
Rozpoczęcie ładowania	86
Zakończenie ładowania	87
Świetlne wskaźniki stanu	88
Funkcja	89
Zmiana prądu znamionowego	89
Minutnik	90

⚠ UWAGA

- Korzystanie ze źródła zasilania z zewnętrznym wyłącznikiem automatycznym.
- Upewnij się, że ładowarka jest używana w bezpiecznym miejscu i jest poza zasięgiem małych dzieci i zwierząt.
- Z przedmiotowego produktu należy korzystać w chłodnym, suchym i dobrze wentylowanym miejscu, nie dopuszczając do przedostania się wody do wtyczki.
- Nie otwierać obudowy podczas ładowania ani wtedy, gdy ładowarka jest włączona.
- Uważać, aby nie uszkodzić produktu.

Przedstawienie przenośnej ładowarki do pojazdów elektrycznych (Mode 2)

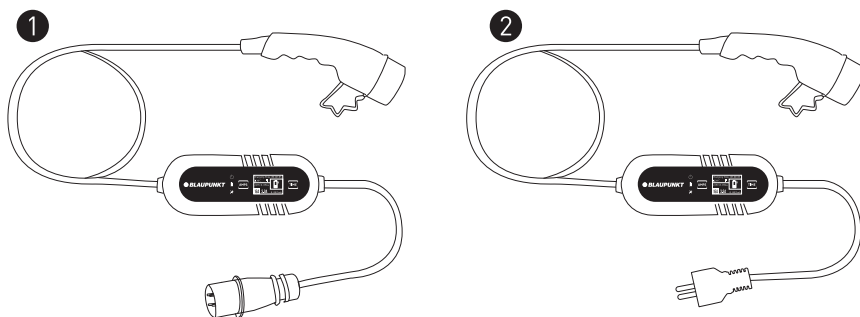

Dane techniczne

Model	Rodzaj zasilania	Całk. długość przewodu	Napięcie	Prąd znamionowy	Typ złącza
P1PM2T2	Jednofazowe	8m	200-250V	8/10/13/16A	T2
P1PM2T1	Jednofazowe	8m	200-250V	8/10/13/16A	T1
P1PM2T2C	Jednofazowe	8m	200-250V	8/10/13/16A	T2
P3PM2T2	Trójfazowe	8m	380-450V	8/10/13/16A	T2
P1PM2T2BS	Jednofazowe	8m	200-250V	8/10/13A	T2
P1PM2T1BS	Jednofazowe	8m	200-250V	8/10/13A	T1
P3P6MT2	Trójfazowe	6m	380-450V	8/10/13/16A	T2
P1P6MT2	Jednofazowe	6m	200-250V	8/10/13/16A	T2
P1P6MT2L	Jednofazowe	6m	200-250V	8/10/13/16A	T2
P1PM2T2L	Jednofazowe	8m	200-250V	8/10/13/16A	T2
P1PM2T2CH	ednofazowe	8m	200-250V	8/10A	T2
P1PM2T2DK	ednofazowe	8m	200-250V	6A	T2

Parametry techniczne i znaczenie wskaźników kontrolera

1 Model: P3PM2T2 / P3P6MT2

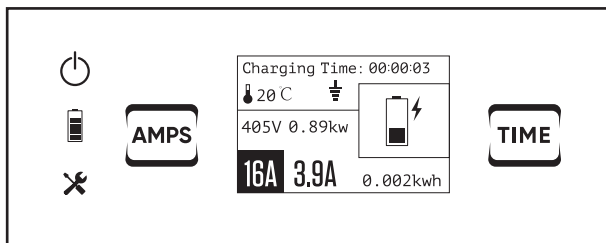

Znaczenie wskaźników kontrolera

	Wł./wył. zasilania	405V	Napięcie
	Ładowanie	0.89kw	Zasilanie
	Wskaźnik problemów	16A	Prąd znamionowy
	Przycisk zmiany prądu znamionowego	3.9A	Prąd stały
00:00:03	Czas ładowania	0.002kwh	Zużycie energii
	Temperatura		Przycisk funkcji czasu
	Wykrywanie PE (wykrywanie uziemienia)		PE upstream nie został wykryty i nie można rozpocząć ładowania.

Control box :

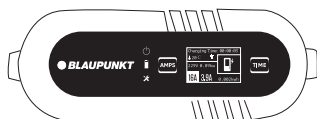

Parametry techniczne

Wymiary (dł. x szer. x wys.)	260 × 100 × 72.5 mm
Waga	wersja trójfazowa: 3.35 kg / 2.9 kg
Stopień ochrony (Control box)	IP65
Temperatura robocza	Od -30°C do +50°C

Parametry techniczne i znaczenie wskaźników kontrolera

- 1 Model: P1PM2T2 / P1PM2T1 / P1PM2T2C / P1PM2T2BS / P1PM2T1BS
P1P6MT2 / P1P6MT2L / P1PM2T2L / P1PM2T2CH / P1PM2T2DK

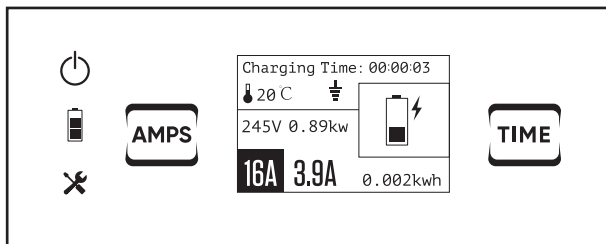

Znaczenie wskaźników kontrolera

	Wł./wył. zasilania	245V	Napięcie
	Ładowanie	0.89kw	Zasilanie
	Wskaźnik problemów	16A	Prąd znamionowy
	Przycisk zmiany prądu znamionowego	3.9A	Prąd stały
00:00:03	Czas ładowania	0.002kwh	Zużycie energii
	Temperatura		Przycisk funkcji czasu
	Wykrywanie PE (wykrywanie uziemienia)		PE upstream nie został wykryty i nie można rozpocząć ładowania.

Control box :

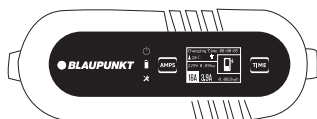

Parametry techniczne

Wymiary (dł. x szer. x wys.)	260 × 100 × 72.5 mm
Waga	Wersja jednofazowa: 2.41 kg / 2.15 kg
Stopień ochrony (Control box)	IP65
Temperatura robocza	Od -30°C do +50°C

Objaśnienie symboli "⚡" "⚡!"

Użytkownicy muszą sprawdzić znak wykrywania PE "⚡" na wyświetlaczu przed każdym użyciem (PE oznacza przewód ochronny) .

1. Jeśli na ekranie pojawi "⚡" się Znak, oznacza to, że ładowarka powinna sprawdzić obecność PE upstream, a proces ładowania rozpocznie się dopiero wtedy, gdy PE upstream będzie obecny.

UWAGA: jeśli pojawi "⚡!" się znak, oznacza to, że PE upstream nie został wykryty i ładowanie nie może zostać rozpoczęte.

2. Jeśli znak "⚡" NIE jest wyświetlany na ekranie, oznacza to, że ładowarka nie ma funkcji sprawdzania obecności PE upstream i może być ładowana niezależnie od tego, czy PE może być wykryty, czy nie.

UWAGA: Zdecydowanie zaleca się, aby użytkownicy ładowali zgodnie z warunkiem 1. Warunek 2 wiąże się z pewnymi zagrożeniami bezpieczeństwa ze względu na brak urządzenia PE. Tak więc Warunek 2 powinien być stosowany tylko przy założeniu, że użytkownicy mogą zapewnić bezpieczeństwo i w szczególnych okolicznościach, gdy PE nie występuje w systemie energetycznym.

Dezaktywacja wykrywania PE:
Reaktywacja wykrywania PE:

Naciśnij "Amps+Time" przez 4s razem.
Naciśnij "Amps+Time" przez 4s razem.

Użytkowanie: Rozpoczęcie ładowania

Rozpoczęcie ładowania

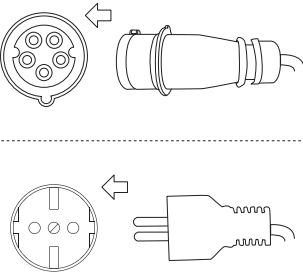
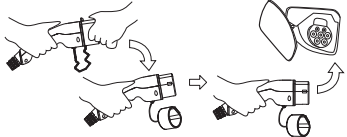
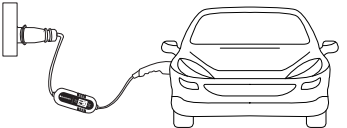
krok	Ilustracja	Obsługa
1.		Włożyć wtyczkę do odpowiedniego gniazda zasilania.
2.		Usunąć pokrywkę ochronną i całkowicie włożyć złącze ładowania do portu ładowania pojazdu elektrycznego.
3.		Rozpocząć ładowanie.

NIEBEZPIECZEŃSTWO

Nie używać produktu, jeśli wygląda na uszkodzony lub w przypadku pęknięcia przewodu.

Nie rozmontowywać ani nie montować złącza i nie wymieniać wewnętrznych części.





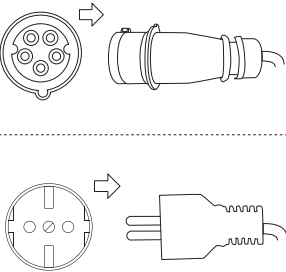
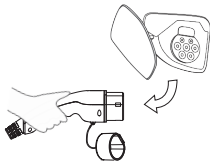
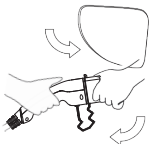
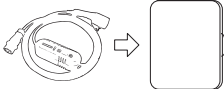



Nie czyścić produktów za pomocą środków chemicznych ani nie czyścić samochodu elektrycznego podczas ładowania.

Zakończenie ładowania



















Krok	Ilustracja	Obsługa
1.		Wyjąć wtyczkę z gniazda zasilania.
2.		Odłączyć złącze do ładowania od pojazdu elektrycznego.
3.		Zamknąć pokrywę ochronną portu ładowania pojazdu elektrycznego i następnie zamknąć pokrywę ochronną złącza ładowania.
4.		Włożyć ładowarkę przenośną do torby

Światłne wskaźniki stanu

























Światłne wskaźniki stanu

Wskaźnik świetlny	Stan	Wskaźnik świetlny	Stan	Wskaźnik świetlny	Stan
	Wył.		Miganie		Wył.
	Wył.		Miganie		Wył.
	Wył.		Miganie		Wył.

Obsługa:

1	Wył. zasilania			
2	Diagnostyka			
3	Tryb gotowości			
4	Połączenie aktywne			
5	Ładowanie			
6	Ładowanie zakończone			

Rozwiązywanie problemów:



1	Błąd CP			
2	Błąd przełącznika			
3	Zbyt niskie/wysokie napięcie			
4	Ochrona przed przepięciem			
5	Ochrona przed prądem upływowym			
6	Brak uziemienia			
7	Ostrzeżenie dotyczące temperatury			
8	Stała wysoka temperatura			

Funkcja: Zmiana prądu znamionowego

Zmiana prądu znamionowego:

UWAGA

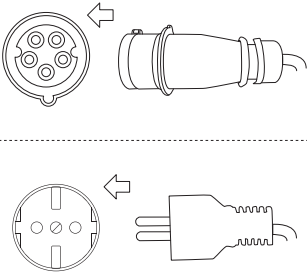
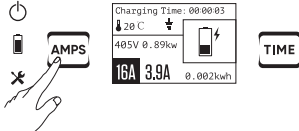
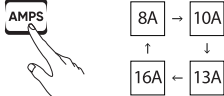
Przed zmianą prądu ładowania należy sprawdzić, czy wtyczka zasilająca jest dobrze włożona do gniazda oraz czy drugi koniec przewodu jest odłączony od pojazdu elektrycznego.

Krok	Ilustracja	Stan
1. Włożyć wtyczkę do odpowiedniego gniazda zasilania.		Gotowy
2. Wcisnąć przycisk "Amps" ("Prąd") i przytrzymać go przez 2 sekundy.		Przechodzenie do trybu ustawień prądu
3. Przełączyć między prądem 8, 10, 13 i 16 A poprzez szybkie wciśnięcie przycisku.		Ustawianie prądu znamionowego zgodnie z potrzebami użytkownika
4. Ponownie wcisnąć i przytrzymać przycisk przez 2 sekundy.		Ustawianie prądu znamionowego zakończone powodzeniem



W każdym kroku należy wykonać w przeciągu 4 sekund, w przeciwnym razie tryb ustawiania zostanie wyłączony

Funkcja: Minutnik

Funkcja minutnika:

UWAGA

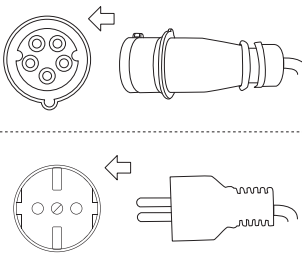
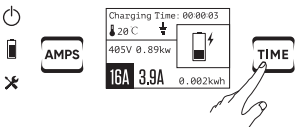
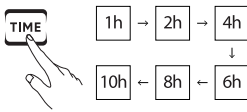
Przed włączeniem funkcji minutnika należy sprawdzić, czy wtyczka zasilająca jest dobrze włożona do gniazda oraz czy drugi koniec przewodu jest odłączony od pojazdu elektrycznego

Krok	Ilustracja	Stan
1. Włożyć wtyczkę do odpowiedniego gniazda zasilania.		Gotowy
2. Wcisnąć przycisk „Time” („Czas”) i przytrzymać go przez 2 sekundy.		Przechodzenie do trybu ustawień funkcji minutnika. Minutnik zapewnia opóźnienie włączenia o wybraną liczbę godzin
3. Przełączyć między prądem 1, 2, 4, 6, 8 o 10 godzinami poprzez szybkie wciśnięcie przycisku.		Ustawianie minutnika zgodnie z potrzebami użytkownika
4. Ponownie wcisnąć i przytrzymać przycisk przez 2 sekundy.		Ustawianie minutnika zakończone powodzeniem

Każdy krok należy wykonać w przeciągu 4 sekund, w przeciwnym razie tryb ustawiania zostanie wyłączony.

Uwaga:

Jeśli konieczne będzie anulowanie funkcji minutnika po rozpoczęciu odliczania, można wykonać jeden z następujących kroków:



1. Bezpośrednio odłączyć wtyczkę od gniazda lub
2. Naciśnąć przycisk minutnika i przytrzymać go przez 5 sekund.

Carregador portátil do VE

Leia atentamente as seguintes instruções antes de carregar o seu Veículo Elétrico, esteja atento aos perigos envolvidos com o circuito elétrico e as práticas padrão para prevenir acidentes.

Portoghese

Índice

Introdução ao carregador portátil do VE (Mode 2)	92
Significado dos indicadores e parâmetros técnicos do controlador	93
Explicação do "  " e dos "  ! " símbolos	95
Utilização	96
Começar a carregar	96
Parar de carregar	97
Visor do estado da luz	98
Função	99
Alteração de corrente nominal	99
Temporizador	100

Introdução ao carregador portátil do VE (Mode 2)

! CUIDADO

- Utilize a fonte de alimentação com um disjuntor externo.
- Certifique-se de que o carregador é utilizado num local seguro, fora do alcance de crianças pequenas ou animais de estimação.
- Utilize este produto numa área fresca, seca e bem ventilada; evite a entrada de água na ficha.
- Não abra o invólucro enquanto estiver a carregar ou quando o carregador estiver ligado.
- Não danifique o produto de forma maliciosa.

Introdução do carregador portátil do VE (Mode 2)

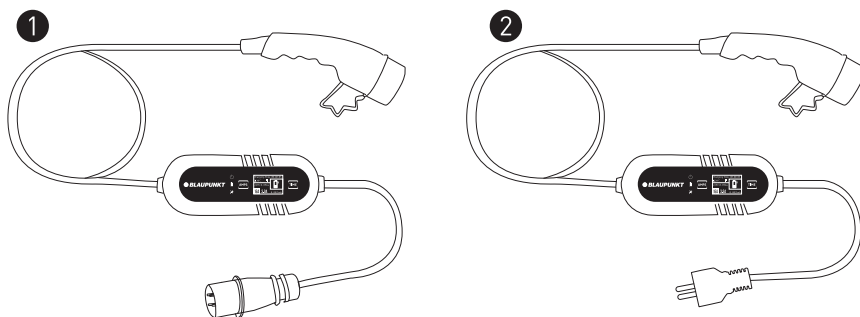

Especificações

Modelo	Tipo na fonte de alimentação	Comprimento total do cabo	Tensão	Corrente nominal	Tipo de conector
P1PM2T2	Monofásico	8m	200-250V	8/10/13/16A	T2
P1PM2T1	Monofásico	8m	200-250V	8/10/13/16A	T1
P1PM2T2C	Monofásico	8m	200-250V	8/10/13/16A	T2
P3PM2T2	Trifásico	8m	380-450V	8/10/13/16A	T2
P1PM2T2BS	Monofásico	8m	200-250V	8/10/13A	T2
P1PM2T1BS	Monofásico	8m	200-250V	8/10/13A	T1
P3P6MT2	Trifásico	6m	380-450V	8/10/13/16A	T2
P1P6MT2	Monofásico	6m	200-250V	8/10/13/16A	T2
P1P6MT2L	Monofásico	6m	200-250V	8/10/13/16A	T2
P1PM2T2L	Monofásico	8m	200-250V	8/10/13/16A	T2
P1PM2T2CH	Monofásico	8m	200-250V	8/10A	T2
P1PM2T2DK	Monofásico	8m	200-250V	6A	T2

Significado dos indicadores e parâmetros técnicos do controlador

1 Modelo: P3PM2T2 / P3P6MT2

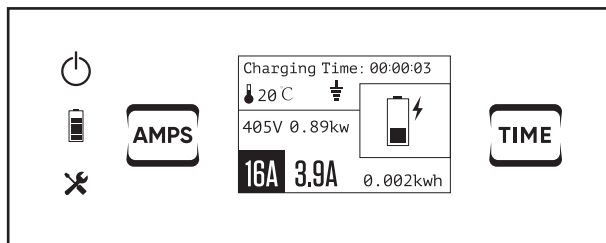

Significado dos indicadores do controlador

	Alimentação ligar/desligar	405V	Tensão
	A carregar	0.89kw	Alimentação:
	Indicador de problemas	16A	Corrente nominal
	Botão para alteração de corrente nominal	3.9A	Corrente constante
00:00:03	Tempo de carregamento	0.002kwh	Consumo de eletricidade
	Temperatura		Botão de função de tempo
	Detecção de PE (detecção de ligação à terra)		O PE a montante não foi detectado e a carga não pode ser iniciada.

Control box :

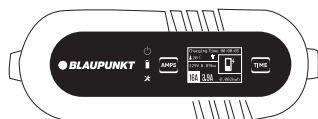

Tekniska parameter

Dimensões (C x L x A)	260 x 100 x 72.5 mm
Peso	Trifásico: 3.35 kg / 2.9 kg
Grau de proteção (Control box)	IP65
Temperatura de funcionamento	-30°C a +50°C

Significado dos indicadores e parâmetros técnicos do controlador

- 1 Modelo: P1PM2T2/P1PM2T1/P1PM2T2C/P1PM2T2BS/P1PM2T1BS
P1P6MT2/P1P6MT2L/P1PM2T2L/P1PM2T2CH/P1PM2T2DK

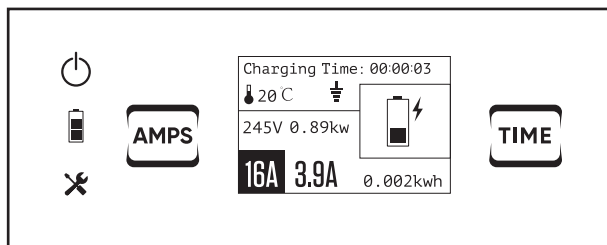

Significado dos indicadores do controlador

	Alimentação ligar/desligar	245V	Tensão
	A carregar	0.89kw	Alimentação:
	Indicador de problemas	16A	Corrente nominal
AMPS	Botão para alteração de corrente nominal	3.9A	Corrente constante
00:00:03	Tempo de carregamento	0.002kwh	Consumo de eletricidade
	Temperatura	TIME	Botão de função de tempo
	Deteção de PE (deteção de ligação à terra)		O PE a montante não foi detectado e a carga não pode ser iniciada.

Control box :

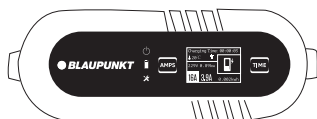

Tekniska parametar

Dimensões (C x L x A)	260 x 100 x 72.5 mm
Peso	Monofásico: 2.41 kg / 2.15 kg
Grau de proteção (Control box)	IP65
Temperatura de funcionamento	-30°C a +50°C

Explicação do "⚡" e dos "⚡!" símbolos

Os utilizadores devem verificar a marca de detecção de PE "⚡" no visor antes de cada utilização. (PE que significa protecção conductor)

1. Se a Marca "⚡" for exibida no ecrã, indica que o carregador deve verificar a presença do PE a montante, e o processo de carregamento só começará quando o PE a montante estiver presente.

ATENÇÃO: se a Marca "⚡!" aparecer, significa que o PE a montante não foi detectado e que a carga não pode ser iniciada.

2. Se a marca "⚡" NÃO for exibida no ecrã, indica que o carregador não tem função para verificar a presença do PE a montante, e pode ser carregado quer o PE possa ou não ser detectado.

ATENÇÃO: É fortemente recomendado que os utilizadores carreguem sob a condição 1. A condição 2 tem certos riscos de segurança devido à ausência de PE. Assim, a Condição 2 só deve ser utilizada sob a premissa de que os utilizadores podem garantir a segurança e em circunstâncias especiais em que não exista PE no sistema eléctrico.

Desactivar a detecção de PE :
Reativar a Detecção de PE:

Pressionar "Amps+Time" durante 4s em conjunto.
Pressionar "Amps+Time" durante 4s em conjunto

Utilização: Começar a carregar

Começar a carregar

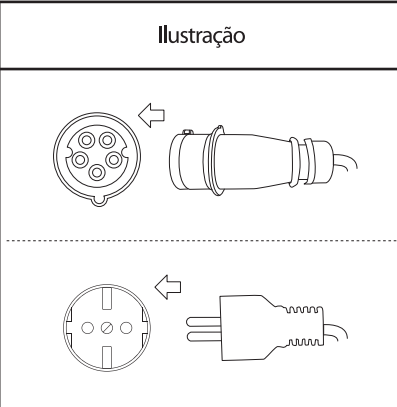
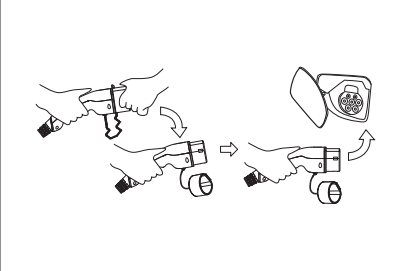
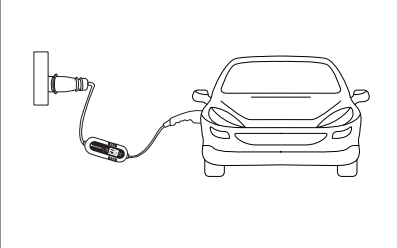
Passo	Ilustração	Operação
1.		Insira a ficha na tomada de alimentação correta.
2.		Remova a tampa de proteção e introduza totalmente o conector de carregamento na porta de carga do VE.
3.		Começar a carregar.

PERIGO



Não utilize o produto se este parecer estar danificado ou se o cabo estiver partido.

Não desmonte nem monte o conector e troque as peças internas.

Não limpe os produtos utilizando produtos químicos ou limpando o carro VE enquanto estiver a carregar.

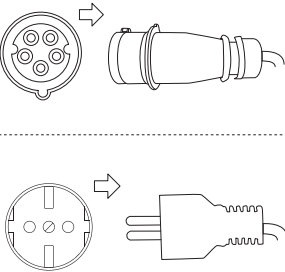
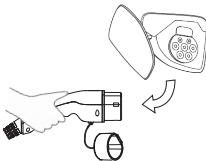
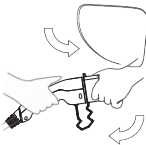

Utilização: Parar de carregar

Parar de carregar



















Passo	Ilustração	Operação
1.		Desligue a ficha da tomada de alimentação.
2.		Desligue o conector de carregamento do veículo VE.
3.		Feche o invólucro de proteção da porta de carregamento do VE e cubra a tampa de proteção do conector de carregamento.
4.		Coloque o carregador portátil no saco.

Visor do estado da luz

















Visor do estado da luz

Luz indicadora	Estado	Luz indicadora	Estado	Luz indicadora	Estado
	Desligado		A piscar		Ligado
	Desligado		A piscar		Ligado
	Desligado		A piscar		Ligado

Operação:

1	Alimentação desligar			
2	Verifique			
3	Em espera			
4	Ligado			
5	A carregar			
6	Carga completa			

Resolução de problemas:



1	Erro do CP			
2	Erro de relé			
3	Sobretensão/subtensão			
4	Proteção de sobrecorrente			
5	Proteção contra fuga elétrica			
6	Não ligado à terra			
7	Aviso de temperatura			
8	Temperatura elevada persistente			

Função: Alteração de corrente nominal

Alteração de corrente nominal:

CUIDADO

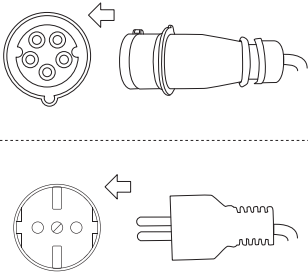
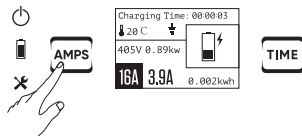
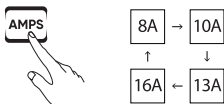
Antes de alterar a corrente de carregamento, certifique-se de que a ficha está firmemente introduzida na tomada e que a outra extremidade do cabo está desligada do veículo VE.

Passo	Ilustração	Estado
1. Insira a ficha na tomada de alimentação correta.		Pronto
2. Mantenha o botão "Amps" pressionado durante 2 segundos.		A introduzir o modo de definições de corrente
3. Alterne entre correntes 8, 10, 13 e 16 A ao pressionar o botão brevemente.		Definir a corrente nominal conforme as necessidades do utilizador
4. Prima o botão durante dois segundos novamente.		Definição da corrente nominal bem sucedida



complete a definição em 4 segundos em cada passo, caso contrário o modo de definição será desativado.

Função: Temporizador

Função do temporizador:

CUIDADO

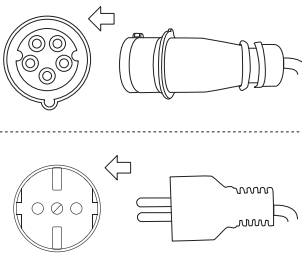
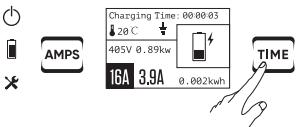
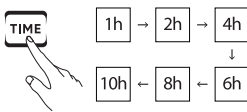
Antes de ativar a função do temporizador, certifique-se de que a ficha está firmemente introduzida na tomada e que a outra extremidade do cabo está desligada do veículo VE.

Passo	Ilustração	Estado
1. Insira a ficha na tomada de alimentação correta.		Pronto
2. Mantenha o botão "Tempo" pressionado durante 2 segundos.		A entrar no modo de definições da função Temporizador. O temporizador atrasará o início pelo número de horas selecionado
3. Alterne entre 1, 2, 4, 6, 8 e 10 H vezes, ao pressionar o botão brevemente.		Definir o Temporizador conforme as necessidades do utilizador
4. Prima o botão durante dois segundos novamente.		Definição do Temporizador bem sucedida

Complete a definição em 4 segundos em cada passo, caso contrário o modo de definição será desativado.

Nota:

Se deseja cancelar a função Tempo após o início da contagem decrescente, pode tomar uma das seguintes medidas:



1. Desligar diretamente a ficha da tomada; ou
2. Prima o botão de Tempo durante 5 segundos

EV bärbar laddare

Läs noggrant igenom följande anvisningar innan du laddar ditt elektriska fordon. Du ska vara medveten om riskerna med elektrisk ström och standardpraxis för att förhindra olyckor.

Svenska

Innehåll

Introduktion till den bärbara EV-laddaren (Mode 2)	102
Betydelsen av kontrollindikatorer och tekniska parametrar	103
Förklaring av symbolerna "  " och "  ! "	105
Använda	106
Börja laddning	106
Stoppa laddningr	107
Statusindikering för lysdiod	108
Funktion	109
Ändring av märkström	109
Timer	110

Introduktion till den bärbara EV-laddaren (Mode 2)

⚠ FÖRSIKTIGHETSÅTGÄRD

- Använd strömkällan med en extern strömbrytare.
- Säkerställ att laddaren används i en säker och trygg miljö väl utom räckhåll för små barn eller husdjur.
- Denna produkt ska användas i ett svalt, torrt och väl ventilerat område. Undvik att vatten tränger in i stickkontakten.
- Öppna inte höljet när du laddar eller när laddaren är påslagen.
- Undvik uppsåtlig skadegörelse på produkten.

Introduktion av bärbar EV-laddare (Mode 2)

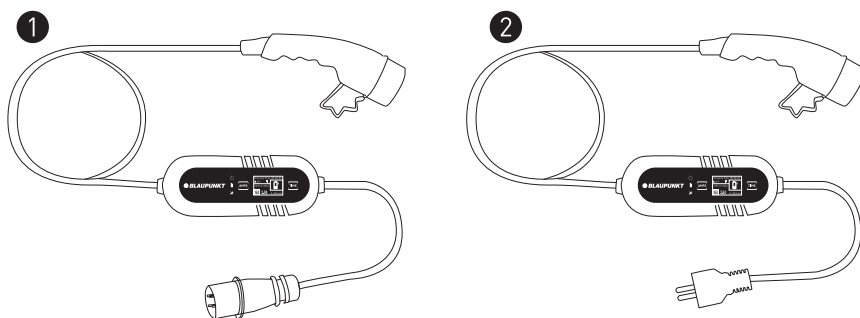

Specifikationer

Modell	Typ av strömförsörjning	Kabelns totala längd	Spänning	Märkström	Typ av kontaktdon
P1PM2T2	Enfas	8m	200-250V	8/10/13/16A	T2
P1PM2T1	Enfas	8m	200-250V	8/10/13/16A	T1
P1PM2T2C	Enfas	8m	200-250V	8/10/13/16A	T2
P3PM2T2	Trefas	8m	380-450V	8/10/13/16A	T2
P1PM2T2BS	Enfas	8m	200-250V	8/10/13A	T2
P1PM2T1BS	Enfas	8m	200-250V	8/10/13A	T1
P3P6MT2	Trefas	6m	380-450V	8/10/13/16A	T2
P1P6MT2	Enfas	6m	200-250V	8/10/13/16A	T2
P1P6MT2L	Enfas	6m	200-250V	8/10/13/16A	T2
P1PM2T2L	Enfas	8m	200-250V	8/10/13/16A	T2
P1PM2T2CH	Enfas	8m	200-250V	8/10A	T2
P1PM2T2DK	Enfas	8m	200-250V	6A	T2

Betydelsen av kontrollindikatorer och tekniska parametrar

1 Modell: P3PM2T2 / P3P6MT2

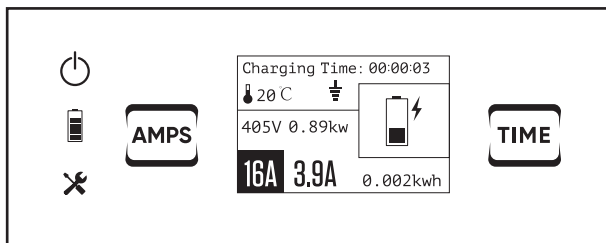

Betydelsen av kontrollindikatorer

	Ström på/av	405V	Spänning
	Laddar	0.89kw	Ström
	Indikator för felsökning	16A	Märkström
AMPS	Knappen för märkströmändring	3.9A	Konstant strömstyrka
00:00:03	Laddningstid	0.002kwh	Elförbrukning
20 C	Temperatur	TIME	Knappen för tidsfunktion
	PE-detektering (jordningsdetektering)		Den uppströms belägna PE:n har inte upptäckts och laddningen kan inte startas.

Control box :

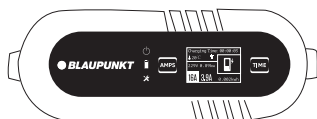

Tekniska parametrar

Mått (L × B × H)	260 × 100 × 72.5 mm
Vikt	3-fas: 3.35 kg / 2.9 kg
Skyddsgrad(Control box)	IP65
Drifttemperatur	-30°C till +50°C

Betydelsen av kontrollindikatorer och tekniska parametrar

- 1 Modell: P1PM2T2 / P1PM2T1 / P1PM2T2C / P1PM2T2BS / P1PM2T1BS
P1P6MT2 / P1P6MT2L / P1PM2T2L / P1PM2T2CH / P1PM2T2DK

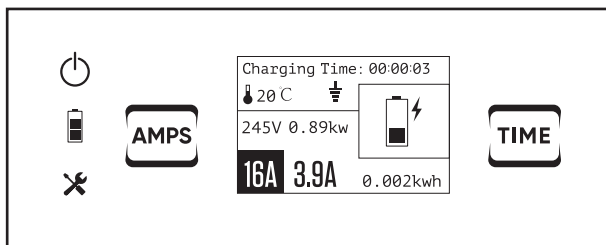

Betydelsen av kontrollindikatorer

	Ström på/av	245V	Spänning
	Laddar	0.89kw	Ström
	Indikator för felsökning	16A	Märkström
AMPS	Knappen för märkströmändring	3.9A	Konstant strömstyrka
00:00:03	Laddningstid	0.002kwh	Elförbrukning
20 C	Temperatur	TIME	Knappen för tidsfunktion
	PE-detektering (jordningsdetektering)		Den uppströms belägna PE:n har inte upptäckts och laddningen kan inte startas.

Control box :

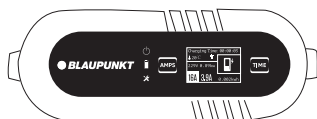

Tekniska parametrar

Mått (L×B×H)	260×100×72.5 mm
Vikt	1-fas: 2.41 kg / 2.15 kg
Skyddsgrad(Control box)	IP65
Drifttemperatur	-30°C till +50°C

Förklaring av symbolerna " $\frac{1}{3}$ " och " $\frac{1}{3}!$ "

Användarna måste kontrollera PE-märket " $\frac{1}{3}$ " på displayen före varje användning. (PE betyder skyddsledare)

1. Om märket visas på skärmen " $\frac{1}{3}$ " indikerar det att laddaren ska verifiera närvaron av uppströms PE, och laddningen påbörjas först när uppströms PE är närvarande.

OBSERVERA: Om märket " $\frac{1}{3}!$ " visas betyder det att PE uppströms inte har upptäckts och att laddningen inte kan påbörjas.

2. Om märket " $\frac{1}{3}$ " INTE visas på skärmen betyder det att laddaren inte har någon funktion för att verifiera närvaron av PE i uppströmsledet, och kan laddas oavsett om PE kan upptäckas eller inte.

UPPMÄRKSAMHET: Det rekommenderas starkt att användarna laddar under villkor 1. Villkor 2 innebär vissa säkerhetsrisker på grund av att det inte finns någon PE. Därför bör villkor 2 endast användas under förutsättning att användarna kan garantera säkerheten och under särskilda omständigheter där det inte finns någon PE i kraftsystemet.

Inaktivera PE-detektering:
Återaktivera PE-detektering:

Tryck på "Amps+Time" i 4 sekunder samtidigt.
Tryck på "Amps+Time" i 4 sekunder samtidigt.

Använda: Börja laddning

Börja laddning

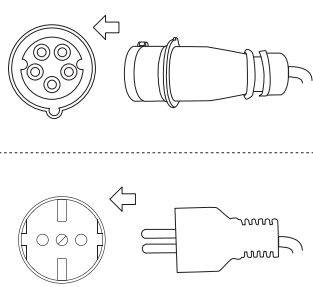
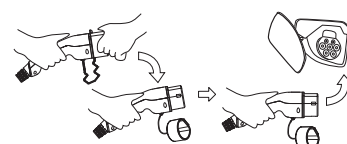
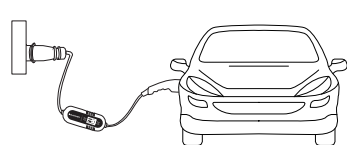

Steg	Illustration	Drift
1.		Sätt i stickkontakten i rätt uttag för strömförsörjning.
2.		Plocka bort skyddskåpan och sätt in kontaktdonet för laddning i EV laddningsport.
3.		Börja laddning

FARA

Produkten ska inte användas om den visar sig vara skadad eller om kabeln är trasig.
Du ska inte demontera inte eller montera kontaktdonet eller ändra de inre delarna.
Produkterna ska inte rengöras med kemikalier eller EV-bilen under laddning.



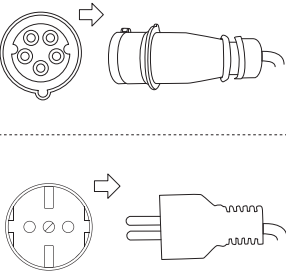
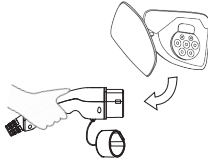
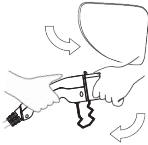





Använda: Stoppa laddning

Stoppa laddning



















Steg	Illustration	Drift
1.		Koppla bort stickkontakten från uttaget till strömförsörjning.
2.		Koppla bort kontaktdonet för laddning från EV-fordonet.
3.		Stäng skyddslocket till EV-laddningsport, och täck sedan skyddslocket på kontaktdonet för laddning.
4.		Lägg den bärbara laddaren i väskan.

Statusindikering för lysdiod

























Statusindikering för lysdiod

Indikatorlampa	Status	Indikatorlampa	Status	Indikatorlampa	Status
	Off (Av)		Blinkar		On (På)
	Off (Av)		Blinkar		On (På)
	Off (Av)		Blinkar		On (På)

Drift:

1	Ström Av			
2	Kontroll			
3	Standby-läge			
4	Ansluten			
5	Laddar			
6	Laddning slutförd			

Felsökning:

1	Fel på CP			
2	Reläfel			
3	Överspänning/underspänning			
4	Överströmsskydd			
5	Elektriskt läckageskydd			
6	Inte jordad			
7	Temperaturvarning			
8	Ihållande hög temperatur			

Funktion: Ändring av märkström

Ändring av märkström:

FÖRSIKTIGHETSÅTGÄRD

Innan du ändrar laddningsström, ska du säkerställa att stickkontakten sitter ordentligt i uttaget och att den andra kabeländen är bortkopplad från EV-fordonet.

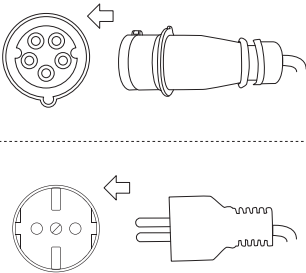
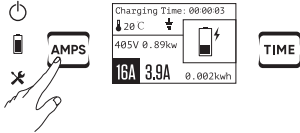
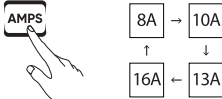
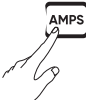
Steg	Illustration	Status
1. Sätt i stickkontakten i rätt uttag för strömförsörjning.		Klar
2. Håll knappen "Ampere" nedtryckt i 2 sekunder.		Anger aktuellt strömläge
3. Växla mellan 8, 10, 13 och 16 A-strömmar genom att trycka kort på knappen.		Ställa in märkströmmen efter användarens behov
4. Tryck på knappen i 2 sekunder.		Märkströminställning klar



Slutför inställningen inom 4 sekunder vid varje steg, annars kommer inställningsläget att inaktiveras.

Funktion: Timer

Timer-funktion:

FÖRSIKTIGHETSÅTGÄRD

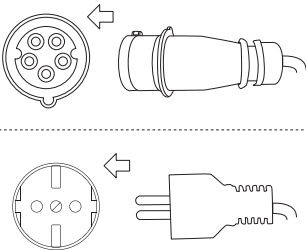
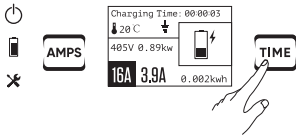
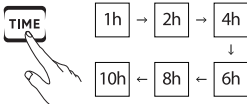
Innan du aktiverar timerfunktionen, ska du säkerställa att stickkontakten sitter ordentligt i uttaget och att den andra kabeländen är bortkopplad från EV-fordonet.

Steg	Illustration	Status
1. Sätt i stickkontakten i rätt uttag för strömförsörjning.		Klar
2. Håll knappen "Tid" nedtryckt i 2 sekunder.		Anger inställningsläget för timerfunktionen. Timern fördröjer starten med det valda antalet timmar
3. Växla mellan 1, 2, 4, 6, 8 och 10 H gånger genom att trycka kort på knappen.		Ställa in timern efter användarens behov
4. Tryck på knappen i 2 sekunder.		Inställning av timer slutförd

Slutför inställningen inom 4 sekunder vid varje steg, annars kommer inställningsläget att inaktiveras.

Observera:

Om du vill avbryta tidsfunktionen efter att nedräkningen börjat, kan du ta något av de följande stegen:



1. Dra ur stickkontakten direkt från uttaget; eller
2. Håll tidsknappen nedtryckt i 5 sekunder

Bærbar EV Oplader

Les nøye gjennom instruksjonene nedenfor før du lader elbilen din, vær oppmerksom på farene forbundet med elektrisk strøm og standard praksis for å forhindre ulykker.

Norsk

Innholdsfortegnelse

Introduksjon til den bærbare EV Oplader (Mode 2)	112
Betydningen av driftsindikatorer og tekniske parametere	113
Forklaring av symbolet "  " og symbolet "  ! "	115
Brug	116
Startavgiften	116
Stopoplading	117
Lysstatusdisplay	118
Funksjon	119
Endring i nominell strømning	119
Funksjon Timer	120

Introduksjon til den bærbare EV Oplader (Mode 2)

FORSIKTIG

- Bruk strømkilden med en ekstern bryter.
- Sørg for at laderen brukes på et trygt sted, utilgjengelig for små barn eller kjæledyr.
- Bruk dette produktet på et kjølig, tørt og godt ventilert sted. Unngå at vann kommer inn i kontakten.
- Ikke åpne dekselet under lading eller når laderen er i bruk.
- Unngå å skade produktet.
- Må ikke brukes med en adapter. Koble kun direkte til en fastmontert stikkontakt eller veggbryter.

Introduksjon til den bærbare elbilladeren (Mode 2)

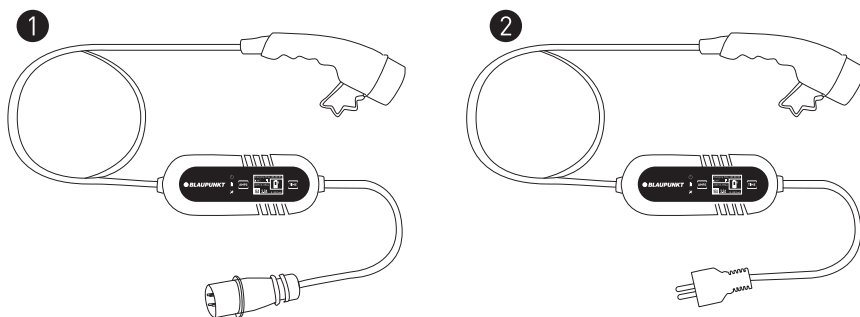

Spesifikasjoner

Modell	enhet Strømforsynings type	kabellengde Total	Spenning	strøm Nominell	Stikktilkobling Type
P1PM2T2	Én fase	8m	200-250V	8/10/13/16A	T2
P1PM2T1	Én fase	8m	200-250V	8/10/13/16A	T1
P1PM2T2C	Én fase	8m	200-250V	8/10/13/16A	T2
P3PM2T2	Trefase	8m	380-450V	8/10/13/16A	T2
P1PM2T2BS	Én fase	8m	200-250V	8/10/13A	T2
P1PM2T1BS	Én fase	8m	200-250V	8/10/13A	T1
P3P6MT2	Trefase	6m	380-450V	8/10/13/16A	T2
P1P6MT2	Én fase	6m	200-250V	8/10/13/16A	T2
P1P6MT2L	Én fase	6m	200-250V	8/10/13/16A	T2
P1PM2T2L	Én fase	8m	200-250V	8/10/13/16A	T2
P1PM2T2CH	Én fase	8m	200-250V	8/10A	T2
P1PM2T2DK	Én fase	8m	200-250V	6A	T2

Betydningen av driftsindikatorer og tekniske parametere

1 Modell: P3PM2T2 / P3P6MT2

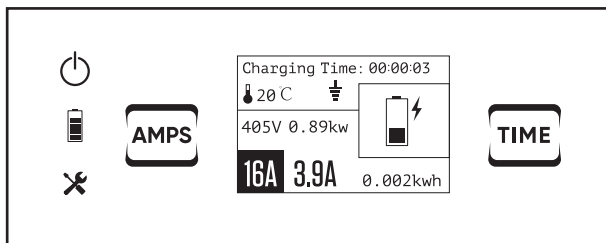

Betydningen av kontrollindikatorene

	Strøm på/av	405V	Spenning
	Lader	0.89kw	Strømforbruk
	Feilindikator	16A	Nominell strøm
	Nominell Endre-knapp strøm	3.9A	Konstant strøm
00:00:03	Ladetid	0.002kwh	Strømforbruk
	Temperatur		Knapp for timerfunksjon
	PE-deteksjon (jordingsdeteksjon)		Oppstrøms PE har ikke blitt oppdaget, og ladingen kan ikke startes

Kontrollboks:

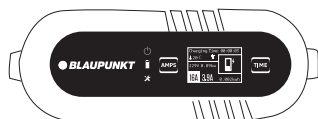

Tekniske parametere

Dimensjoner (L x B x H)	260 x 100 x 72.5 mm
Vekt	3-fas: 3.35 kg / 2.9 kg
Beskyttelsesgrad (kontrollboks)	IP65
Driftstemperatur	-30°C til +50°C

Betydningen av driftsindikatorer og tekniske parametere

- 1 Modell: P1PM2T2 / P1PM2T1 / P1PM2T2C / P1PM2T2BS / P1PM2T1BS
P1P6MT2 / P1P6MT2L / P1PM2T2L / P1PM2T2CH / P1PM2T2DK

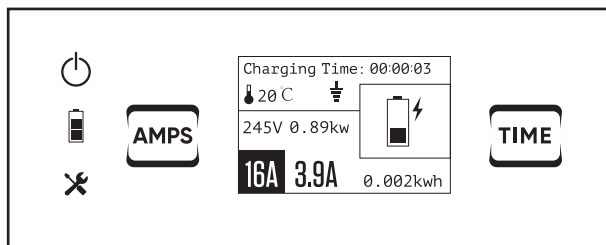

Betydelsen av kontrollindikatorer

	Strøm på/av	245V	Spenning
	Lader	0.89kw	Strømforbruk
	Feilindikator	16A	Nominell strøm
	Nominell strøm Endre-knapp	3.9A	Konstant strøm
00:00:03	Ladetid	0.002kwh	Strømforbruk Timer-
	Temperatur		funksjonsknapp
	PE-deteksjon (jordingsdeteksjon)		Oppstrøms PE har ikke blitt oppdaget, og ladingen kan ikke startes.

Kontrollboks:

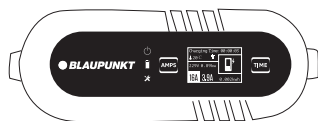

Tekniske parametrar

Dimensjoner (L x B x H)	260 x 100 x 72.5 mm
Vekt	1-fas: 2.41 kg / 2.15 kg
Beskyttelsesgrad (kontrollboks)	IP65
Driftstemperatur	-30°C till +50°C

Forklaring av symbolet "⚡" og symbolet "⚡!"

Brukerne bør kontrollere PE-merket "⚡" på displayet før hver bruk (PE betyr beskyttende jording).

1.Hvis etiketten "⚡" vises på skjermen, betyr det at laderen sjekker om det finnes en oppstrøms PE, og ladeprosessen starter først når oppstrøms PE er til stede.

MERK: Hvis etiketten "⚡!" vises, betyr det at oppstrøms PE ikke er til stede, og at ladingen ikke kan startes.

2.Hvis merket "⚡" ikke vises på skjermen, betyr det at laderen ikke har noen funksjon for å verifisere tilstedeværelsen av oppstrøms PE, og at lading kan skje uavhengig av om PE kan detekteres eller ikke.

MERK: Det anbefales på det sterkeste at brukerne lader under betingelse

1. Betingelse 2 innebærer en viss sikkerhetsrisiko på grunn av fraværet av PE. Betingelse 2 bør derfor bare brukes dersom brukerne kan garantere sikkerheten og under spesifikke omstendigheter der PE ikke er til stede i elsystemet.

Deaktiver PE-deteksjon:
Aktiver PE-deteksjon på nytt:

Trykk på "Amps + Time" i 4 sekunder samtidig.
Trykk på "Amps + Time" i 4 sekunder samtidig.

Bruk: Start lading

Begynn å lade

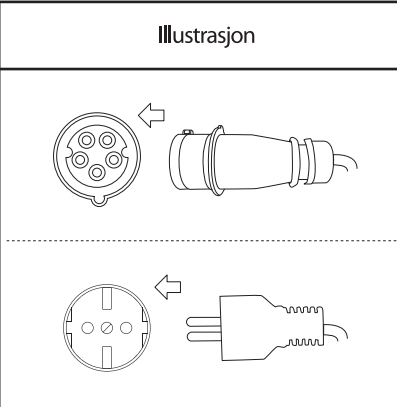
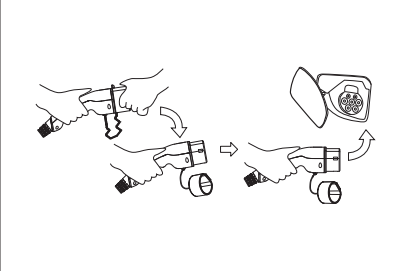
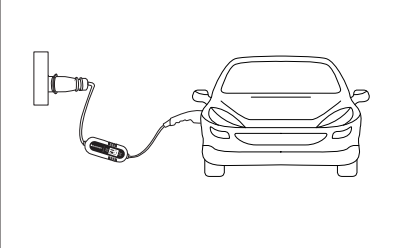

Trinn	Illustrasjon	Drift
1.		Sett støpselet inn i riktig stikkontakt.
2.		Fjern beskyttelseshetten og koble til ladekontakten Helt ind i EV-opladningsport.
3.		Begynn å lade.

FARA

Ikke bruk produktet hvis det ser ut til å være skadet eller hvis kabelen er ødelagt. IKKE demonter kontakten eller skift ut de innvendige delene.



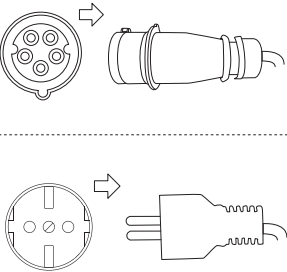
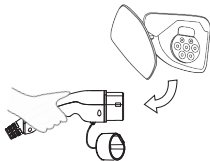
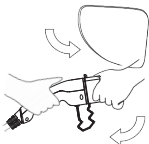





Ikke rengjør produktene med kjemikalier eller rengjør elbilen mens den lades.

Slutt å lade



















Trinn	Illustrasjon	Drift
1.		Trekk støpselet ut av stikkkontakten
2.		Koble ladepluggen fra elbilen.
3.		Lukk beskyttelseshetten på EV-ladeporten og sett den inn beskyttelseshetten på Opldd-kontakten.
4.		Sett inn den bærbare laderen vesken.

Visning av lysstatus

























Visning av lysstatus

Indikatorlampe	Status	Indikatorlampe	Status	Indikatorlampe	Status
	Av (slått av)		Blinklys		På (slått på)
	Av (slått av)		Blinklys		På (slått på)
	Av (slått av)		Blinklys		På (slått på)

Operasjon:

1	Slå av			
2	Sjekk			
3	Standby			
4	Tilkoblet			
5	Lader			
6	Ladingen er fullført			

Feilsøking:



1	CP-feil			
2	Reléfeil			
3	Overspenning/underspenning			
4	Overstrømsbeskyttelse			
5	Beskyttelse mot elektrisk lekkasje			
6	Ikke jordet			
7	Advarsel om temperatur			
8	Vedvarende høy temperatur			

Funksjon: Endring av nominell strøm

Endring av nominell strøm:

FORSIKTIG

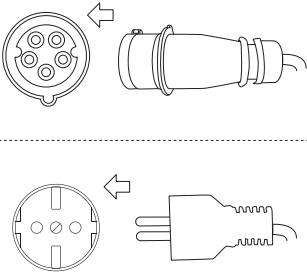
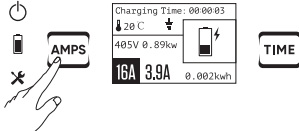
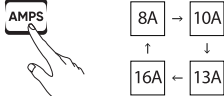
Før du endrer ladestrømmen, må du forsikre deg om at støpselet er satt ordentlig inn i stikkontakten og at den andre enden av kabelen er koblet fra elbilen.

Trinn	Illustrasjon	Status
1. Sett støpselet inn i riktig stikkontakt.		Klar
2. Hold "Amps"-knappen nede i 2 sekunder.		Gå inn i modus for gjeldende innstillinger
3. Veksle mellom 8, 10, 13 og 16 A strømmer av Trykk kort på knappen.		Innstillingen av nominelkraft etter brukerens behov
4. Trykk på knappen i 2 sekunder igjen.		Innstilling av nominell strøm er vellykket

Fullfør innstillingen innen 4 sekunder for hvert trinn, ellers deaktiveres innstillingsmodusen.

Funksjon: Timer

Timerfunksjon:



Før du aktiverer timerfunksjonen, må du kontrollere at støpselet er riktig satt i stikkontakten og at den andre enden av kabelen er koblet fra elbilen.

Trinn	Illustration	Status
1. Sett støpselet inn i riktig stikkontakt.		Trolley
2. Trykk på "Time"- knappen og hold den inne i 2 sekunder.		Gå inn i innstillingsmodus for timerfunksjonen, timeren utsetter starten med det valgte antall timer
3. Veksle mellom 1, 2, 4, 6, 8 og 10t ganger ved å trykke kort på knappen.		Innstilling av timeren i henhold til brukerens behov
4. Trykk på knappen i 2 sekunder igjen.		Timerinnstillingen ble fullført

Fullfør innstillingen innen 4 sekunder for hvert trinn, ellers deaktiveres innstillingsmodusen.

Bemærk:

Hvis du vil avbryte tidsfunksjonen etter at nedtellingen har startet, kan du gjøre følgende:

1. Koble støpselet direkte fra stikkontakten, eller
2. Trykk på Time-knappen i 5 sekunder.

EVSE

Info@blaupunkt-ev.com

BLP EV Systems ApS

Ediths Allé 8

5250 Odense SV

Denmark